

Panasonic

Laser Printer

Model No. **KX-P6500**

Operating Instructions



Please read these instructions completely before operating this unit. Store this manual with care.

End-User License Agreement

THIS IS A LEGAL AGREEMENT BETWEEN YOU AND PANASONIC. CAREFULLY READ ALL THE TERMS AND CONDITIONS OF THIS AGREEMENT PRIOR TO OPENING THE PACKET OF SOFTWARE PROGRAM. OPENING THE PACKET INDICATES YOUR ACCEPTANCE OF THESE TERMS AND CONDITIONS. If you do not agree to these terms and conditions, return the unopened packet and the other components of the Panasonic product to the place of purchase and your money will be refunded. No refunds will be given for the products that have an opened packet or missing components.

1. COPYRIGHT:

Panasonic has the right to license or has been granted to license the enclosed Software Program ("SOFTWARE"), developed and copyrighted by Kyushu Matsushita Electric Co., Ltd. or its licensor ("Licensor"). You acknowledge that you are receiving only a LIMITED LICENSE TO USE the SOFTWARE and related documentation, and that you shall obtain no title, ownership nor any other rights in or to the SOFTWARE and related documentation, all of which title and rights shall remain with Licensor and Panasonic.

2. LICENSE:

(1) You have the non-exclusive right to use the three (3) copies of the SOFTWARE on three (3) computers. (2) You may install the SOFTWARE into a network server and use the SOFTWARE in your network. But the number of the computer which uses the SOFTWARE simultaneously in the network is limited to the number defined in the previous section (1). So far as the computer operates as a network server, the copy of SOFTWARE that is installed into the network server is not counted as the number of copies hereof. (3) You may not copy, reproduce, or permit to be copied or reproduced, the SOFTWARE or related documentation for any purpose, except that you may either (a) make a reasonable quantity of copies of the SOFTWARE solely for backup or archival purposes, or (b) transfer the SOFTWARE to a single hard disk, provided that you keep the original solely for backup or archival purposes. (4) You may not rent or lease the SOFTWARE, but you may transfer your right under this License Agreement on a permanent basis, provided that you transfer this Agreement, all copies of the SOFTWARE, all related documentation and your Panasonic product, and the recipient thereof agrees to the terms of this Agreement. (5) You may not reverse engineer, decompile or disassemble the SOFTWARE, except that in European Union and European Free Trade Association, you may have the limited right to reverse engineer, decompile or disassemble the SOFTWARE solely to the extent specifically permitted by the terms and conditions of Article 6 of the European Community's Directive for the Legal Protection of Computer Programs, OJL 122/42 (17 May 1991). (6) You may not use, copy, modify, alter, or transfer the SOFTWARE, or any copy thereof, in whole or in part, except as expressly provided in this Agreement.

3. TERM:

This license is effective until terminated. You may terminate this Agreement at any time by destroying the SOFTWARE and related documentation and all copies thereof. This license will also terminate if you fail to comply with any term or condition of this Agreement. Upon such termination, you agree to destroy all copies of the SOFTWARE and related documentation.

4. LIMITED WARRANTY:

Within ninety (90) days of your receipt of the SOFTWARE, Panasonic warrants that the storage media on which the SOFTWARE are furnished is free from defect in materials and workmanship under normal use, and that it will repair or at its option replace any defective media at no charge to you, provided that such defective media is returned to Panasonic within such ninety (90) days period.

5. LIMITATION OF LIABILITY:

EXCEPT AS STATED ABOVE, NEITHER PANASONIC NOR PANASONIC'S SUPPLIER MAKES OR PASSES ON TO YOU OR OTHER THIRD PARTY, ANY WARRANTY OR REPRESENTATION INCLUDING, BUT NOT LIMITED TO, THE IMPLIED WARRANTY OF MERCHANTABILITY AND FITNESS FOR A PARTICULAR PURPOSE. WITHOUT LIMITING THE GENERALITY OF THE FOREGOING, NEITHER PANASONIC NOR PANASONIC'S SUPPLIER WARRANTS THAT THE SOFTWARE WILL BE ERROR-FREE OR THAT IT WILL MEET YOUR REQUIREMENTS. NEITHER PANASONIC NOR PANASONIC'S SUPPLIER SHALL BE LIABLE FOR ANY DAMAGE SUFFERED BY YOU INCLUDING, BUT NOT LIMITED TO, CONSEQUENTIAL, INCIDENTAL SPECIAL OR PUNITIVE DAMAGES. THE ABOVE LIMITATIONS SHALL APPLY REGARDLESS OF THE FORM OF ACTION WHETHER IN CONTRACT, TORT (INCLUDING NEGLIGENCE), STRICT PRODUCT LIABILITY OR OTHERWISE, EVEN IF SUCH PARTY HAS BEEN ADVISED OF THE POSSIBILITY OF SUCH DAMAGES.

Caution: This product utilizes a laser.
 Use of controls or adjustments or performance of procedures other than those specified herein may result in hazardous radiation exposure.
 Do not open covers and do not attempt to repair the unit yourself. Refer servicing to qualified personnel.

When you operate this equipment, the electrical outlet should be near the equipment and be easily accessible.

Make sure that printer is installed in a spacious or well ventilated room so as not to increase density of ozone in the air. Since ozone is heavier than air, it is recommended that air at floor level be ventilated.

Warning: The power source voltage of this unit is listed on the nameplate. Plug the printer only into an outlet with the proper voltage. To prevent fire or shock hazard, do not expose this product to rain or moisture.

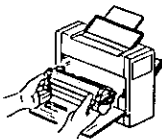

Laser diode properties
 Laser output : 5 mW max
 Wavelength : 788 nm
 Emission duration: Continuous

KX-PEP4



Made in JAPAN

CAUTION
 Use of toner other than Genuine Panasonic Toner KX-P458 can damage this process unit and the printer's fuser. THIS WILL VOID THE WARRANTY OF THE PRINTER AND PROCESS UNIT.

The serial number of the unit may be found on the label on the rear of the unit. For your convenience, record this number below and retain this book along with your proof of purchase to serve as a permanent record of your purchase.

MODEL NO. KX-P6500 NAME OF DEALER _____
 SERIAL NO. _____ DATE OF PURCHASE _____

HP, PCL and LaserJet are trademarks of Hewlett-Packard Company.
 IBM and IBM PC are trademarks of International Business Machines Corporation.
 Microsoft®, MS-DOS® and Windows® are registered trademarks of Microsoft Corporation.
 TrueType is a trademark of Apple Computer, Inc.
 Intel is a trademark of Intel Corporation.
 CompuServe is a trademark of CompuServe, Inc.
 Centronics is a trademark of Centronics Data Computer Corporation.
 Paintbrush is a trademark of ZSoft Corporation.
 PageMaker is a trademark of Aldus Corporation.
 CorelDRAW is a trademark of Corel Corporation.
 EET™, TonrSavR™, WinRefs™, WinStyler™, LaserAct™, WinPanel™, HostPanel™ and MXt™ are trademarks of Destiny Technology Corporation.



As an Energy Star Partner, Panasonic has determined that this product meets the Energy Star guidelines for energy efficiency.

All other acknowledgements are trademarks or registered trademarks of their respective holders.

All Rights Reserved. © COPYRIGHT 1995 KYUSHU MATSUSHITA ELECTRIC CO., LTD.
 © COPYRIGHT, WinRefs™, 1993-1995, Destiny Technology Corporation.
 © COPYRIGHT, WinStyler™, 1992-1995, Destiny Technology Corporation.
 © COPYRIGHT, LaserAct™, 1990-1995, Destiny Technology Corporation.
 © COPYRIGHT, WinPanel™, 1993-1995, Destiny Technology Corporation.
 © COPYRIGHT, HostPanel™, 1993-1995, Destiny Technology Corporation.
 © COPYRIGHT, MXt™, 1995, Destiny Technology Corporation.

Any details given in these Operating Instructions are subject to change without notice.

Caution Label

(110 – 120 V area)

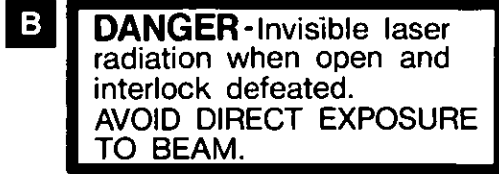

(220 – 240 V area)

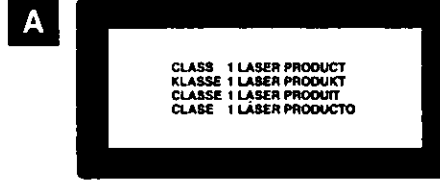

Caution,
hot surface

(220 – 240 V area)

B

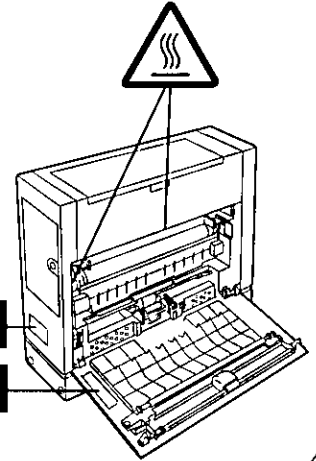

FOR USERS IN UNITED STATES

This equipment has been tested and found to comply with the limits for a Class B digital device, pursuant to Part 15 of the FCC Rules. These limits are designed to provide reasonable protection against harmful interference in a residential installation.

This equipment generates, uses and can radiate radio frequency energy and, if not installed and used in accordance with the instructions, may cause harmful interference to radio communications.

However, there is no guarantee that interference will not occur in a particular installation. If this equipment does cause harmful interference to radio or television reception, which can be determined by turning the equipment off and on, the user is encouraged to try to correct the interference by one or more of the following measures:

- Reorient or relocate the receiving antenna.
- Increase the separation between the equipment and receiver.
- Connect the equipment into an outlet on a circuit different from that to which the receiver is connected.
- Consult the dealer or an experienced radio/TV technician for help.

The user may find the booklet "Something About Interference" available from FCC local regional offices helpful.

FCC Warning: To assure continued FCC emission limit compliance, the user must use the recommended shielded interfacing cable when connecting to a host computer. Also, any unauthorized changes or modifications to this equipment would void the users authority to operate this device.

Technical Support Calls

If you have read this manual and tried the troubleshooting procedures and you are still having difficulty, please contact the store from which the unit was purchased.

You may also call the end user technical support telephone number which is operational during East Coast business hours (9:00 AM to 5:00 PM).

The end user technical support number is 1-800-222-0584.

This number is available within the U.S. only.

Helpful Phone Numbers

To locate your nearest sales dealer	CALL 1-800-742-8086
To order consumables	CALL 1-800-222-0584
To order operating instructions/manuals	CALL 1-206-395-7343
To locate your nearest authorized service center	CALL 1-800-222-0584
For technical support	CALL 1-800-222-0584
Automated 24-hour support	CALL 1-800-222-0584
Fax back	CALL 1-800-222-0584
Electronic bulletin board	CALL 1-201-863-7845

Table of Contents

Chapter 1 *Before You Start*

Printer Features	8
Cautions	9
Minimum Space Requirements	9
Power Source	9
Unpacking	10
System Requirements for Windows	10
System Requirements for MS-DOS	11
Part Names	11
Indicators and Button	12

Chapter 1

Chapter 2

Chapter 2 *Setup — QUICK START*

Preparation	13
Printer Stands Installation	13
Process Unit Installation	13
Connecting the Printer and Power On	14
Loading Paper / Envelopes (Labels, Transparencies)	15
Loading Paper	15
Loading Envelopes (Labels, Transparencies)	16
KX-P6500 for Workgroups Configuration Overview	17
Personal Configuration Overview	17
Network Configuration Overview	17
Server Configuration	17
Client Configuration	18
Network Configuration Example	18
Installing the Network Connection on Your PC	18

Chapter 3

Chapter 4

Chapter 5

Chapter 3 *Using the Printer in Windows®*

Allocating Virtual Memory	19
For Windows 3.1 or Windows for Workgroups 3.11	19
For Windows 95	19
Installing the KX-P6500 for Workgroups Software	20
Installing the Windows 3.1 Printer Driver & Utilities	20
Installing the Windows 95 Printer Driver & Utilities	21
Installing the Software on a Server/Personal	21
Installing the Software on a Client	22
Printer Resource Sharing	23
Stop Sharing the Printer Resource	23
Connecting a Client PC to a Shared Printer	23
Testing the Printer	24
Removing the KX-P6500 for Workgroups Software	24

Appendix

Table of Contents

Print Modes	25
Print Mode Selections	25
Automatic Emulation Switching	25
When the Printer Configuration is Changed	25
Printing Documents	25
Printing From a Windows Application	25
Printing From a DOS Application Within Windows	25
Changing the Print Mode	26
From an Application	26
From the Control Panel in Windows	26
From the Control Panel Tab of the KX-P6500 Console	26
KX-P6500 Console	27
Control Panel	27
Local Queue	29
Changing the Order of Print Jobs	29
Remote Queue	30
Job Log	31
KX-P6500 Console Menu Items	32
File	32
View	32
Settings	32
Network	33
Run	33
KX-P6500 GDI Mode	34
Using Options	36
Using Overlay	37
Overlaying and Printing a Document	38
Using Image Options	40
Using 2 Up/4 Up	40
KX-P6500 PCL Mode	41
PCL Control Panel	41
KX-P6500 Printer Status	43

Chapter 4 ***Using the Printer in MS-DOS®***

Printer Selection for DOS	44
Control Panel Software	44
Installing the Control Panel Software	44
KX-P6500 Control Panel	46
File Menu	46
View Menu	47
Utility Menu	48
Help Menu	48
Control Panel Settings	49
Page Setting	49
Font Setting	50
Print Quality Setting	50
Memory Setting	51
Other Setting	52

KX-P6500 Control Panel Reporter	52
Printer Status Messages	53

Chapter 1

Chapter 5 *Care and Maintenance*

Cleaning the Printer	54
External	54
Internal	54
Troubleshooting	55
Error Indication	56
Repacking Instructions	57

Chapter 2

Chapter 3

Appendix

Options and Supplies	58
Adding Toner	58
Using a KX-P6100 Printer with KX-P6500 for	
Workgroups Software	59
Printer Specifications	60
Paper Specifications	61
Paper Specifications	61
Paper and Envelope Sizes	61
Types of Paper to Avoid	62
Two-sided Printing	62
Transparencies and Labels	62
Envelope Specifications	63
Interface Specifications	64
Bidirectional Parallel Interface	64
Index	65

Chapter 4

Chapter 5

Appendix

Chapter 1 Before You Start

Printer Features

Congratulations on your purchase of the KX-P6500. We are sure it will meet your printing needs and give you many years of productive and efficient use.

■ GDI Mode (P. 34)

GDI Mode takes advantage of Windows' own internal design to print documents four to five times faster than most conventional printers can. Other printers require Windows to translate a document into a special printer language, such as PCL on LaserJet printers. GDI Mode reduces overhead by eliminating this translation step before starting to print. This mode includes the following special features.

1st Page On Top: Prints your document in reverse order ( P. 35).

Duplex Printing: Prints your document on both sides of the paper ( P. 36).

Overlay: Overlays an image over any document ( P. 36).



2 Up/4 Up: Prints 2 or 4 pages on a single sheet of paper to save paper ( P. 35).

Image: Adjusts the brightness and contrast of your output ( P. 40).

■ PCL Mode (P. 41)

Enables you to print a file created with the MS-DOS application or to print a PCL format file within Windows.

■ Printing from MS-DOS file (P. 25, 44)

Allows printing from MS-DOS applications outside Windows as well as from applications within Windows.

■ Toner Saving (P. 32, 50)

With TonrSavR turned on, your printer reduces the amount of toner used to print the output. This feature is useful for printing drafts before the final print to save toner.

■ Edge Enhancement Technology (EET) (P. 32, 51)

With Edge Enhancement turned on, your printer smooths the jagged edges of text and line art.

■ KX-P6500 for Workgroups Software

- Provides three configuration options depending on how you intend to use the printer.

Personal: (Single User) For users that either do not have a network connection or do not plan to share the printer with others on the network.

Server: For users that plan to attach the printer to their PC and have/plans to have a network connection, and may provide printer sharing to other PCs on the network.

Client: For users that will not attach the printer to their PC but do plan to use the printer attached to another PC on the network.

- enables you to install printer driver for Windows 3.1 and Windows for Workgroups 3.11, or Windows 95
- enables you to setup the printer
- displays the printer status
- displays the recovery instructions when a problem occurs
- manages all output to the printer
- provides the help system

■ Power Saving (P. 32)

Saves energy while the printer is idle.

■ Animated Help Feature (P. 43)

The KX-P6500 Printer Status alerts the user of common operational errors. Click the  button for animated help. This feature will walk you through the steps required to get your printer running once again.

■ Bidirectional Parallel Interface (P. 64)

Enables communication between the computer and the printer.

Cautions

To avoid machine malfunction, do not use the printer under the following conditions.

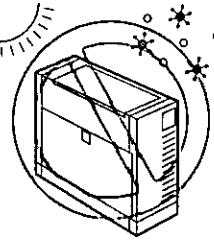
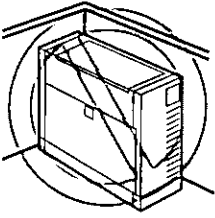
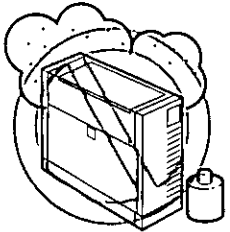
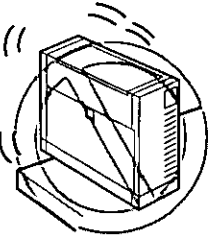
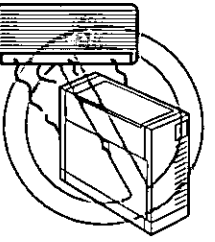
 <ul style="list-style-type: none"> • Direct exposure to sunlight • Extremely high or low temperature • Extremely high or low humidity (humidity range: 20% to 80% RH) 	 <ul style="list-style-type: none"> • Areas of poor ventilation 	 <ul style="list-style-type: none"> • Areas of high dust or chemical fume concentration (solvent etc.) 	 <ul style="list-style-type: none"> • Unstable or unlevel surfaces 	 <ul style="list-style-type: none"> • Directly in front of air conditioning vents
---	---	--	---	---

The following precautions are recommended to extend the life of the printer.

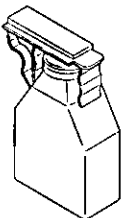
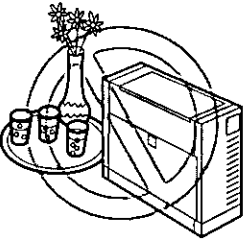
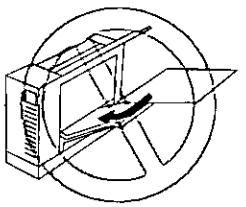
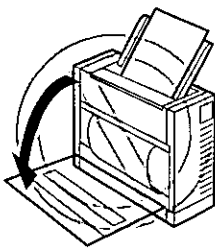
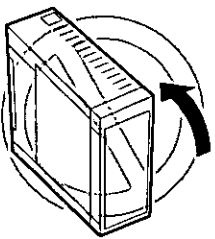
 <ul style="list-style-type: none"> • Use of toner other than Genuine Panasonic Toner KX-P458 can damage this process unit and the printer's fuser. THIS WILL VOID THE WARRANTY OF THE PRINTER AND PROCESS UNIT. 	 <ul style="list-style-type: none"> • Do not keep liquids near the printer. Accidental spillage of a liquid into the printer can cause severe damage. 	 <ul style="list-style-type: none"> • Do not add paper to the tray until it is empty; it may cause a paper jam. 	 <ul style="list-style-type: none"> • Do not open the left cover while the printer is operating. 	 <ul style="list-style-type: none"> • Do not place the printer either on its left or right side or on its front side facing upward.
---	--	--	--	--

Minimum Space Requirements

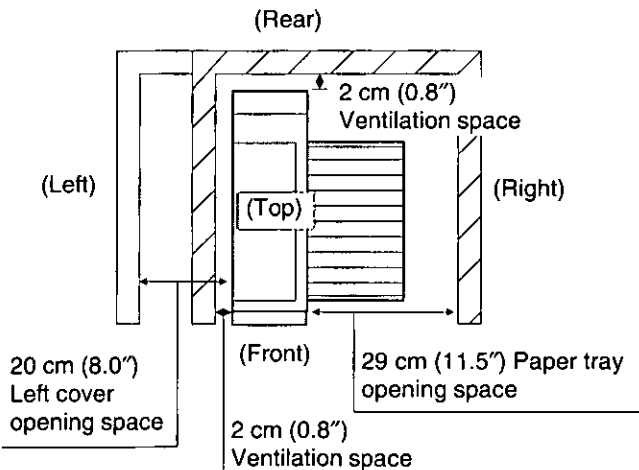

Power Source

- Use a voltage level that does not vary more than $\pm 10\%$ from the voltage level marked on the nameplate (located on the rear of the printer).
- Do not use an extension cord.
- This printer should be connected to a grounded outlet.
- Do not use a line conditioner, transient suppressor or surge protector; it may cause a machine error.

Before You Start

Unpacking

Make sure that all of the items shown below were provided and have not been damaged. Report damage or shortages to the store from which the unit was purchased. Inside the front cover of this manual is an area for recording important information such as the serial number, date of purchase and your dealer name.

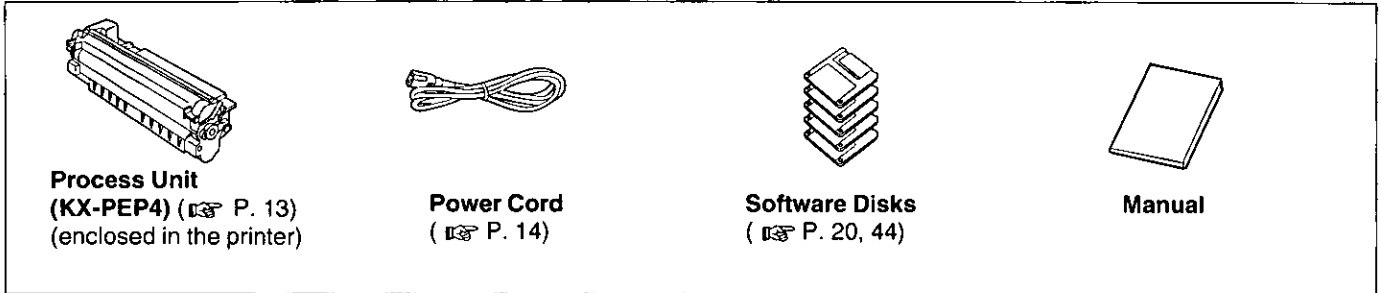

Note:

- It is recommended that you save the original carton and packing materials for future shipping and transporting of the printer. They have been specifically designed to protect your printer during shipment.

System Requirements for Windows

To run the KX-P6500 for Workgroups software, you need the hardware and software given in the following tables. Hardware requirements differ between the three software configuration options: Personal, Server, and Client.

Hardware Requirements		Personal	Server(s)	Client(s)
Minimum CPU	Windows 3.1 or Windows for Workgroups 3.11	i80386SX	i80386DX (i80486DX)*	i80386SX (i80386DX)*
	Windows 95	i80386DX	i80386DX (i80486DX)*	i80386DX
Minimum Processing Speed		16 MHz	33 MHz	16 MHz
Free Disk Space		16 MB	16 MB	16 MB
Minimum RAM		4 MB	8 MB (16 MB *1)	4 MB
Centronics Parallel Port		✓	✓	×
Network Card		×	✓	✓
Network cable, connector(s), and terminator(s)		×	✓	✓
Network adapter driver		×	✓	✓

* Recommended

✓ : required

× : not required

*1 16 MB of RAM is required to support all print modes simultaneously.

Software Requirements	Personal	Server(s)	Client(s)
Windows	Windows 3.1, Windows for Workgroups 3.11 or Windows 95	Windows for Workgroups 3.11 or Windows 95	Windows for Workgroups 3.11 or Windows 95
Minimum Virtual Memory (P. 19)	12 MB	12 MB (24 MB *2)	12 MB
MS-DOS 3.3 or later *3	✓	✓	✓

✓ : required

*2 24 MB of Virtual Memory is required to support all print modes simultaneously.

*3 For Windows 95, MS-DOS is not required.

System Requirements for MS-DOS

To run the Control Panel software, you need the following hardware and software.

Hardware Requirements:

- IBM-compatible 286 computer, or faster
- At least 640 KB PC memory (RAM)
- More than 800 KB hard disk space
- PC with a standard parallel printer port (bidirectional)

Software Requirements:

- MS-DOS 3.3 or later

Part Names

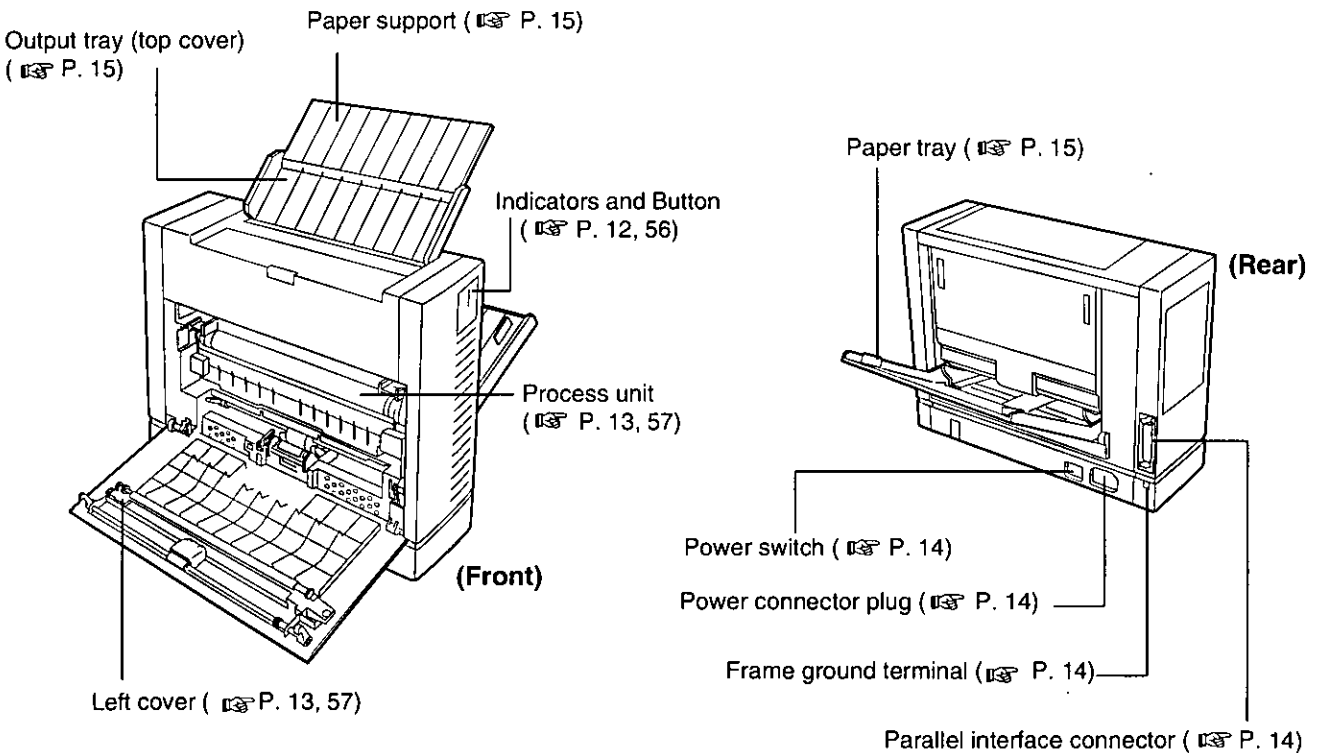

Before You Start

Indicators and Button

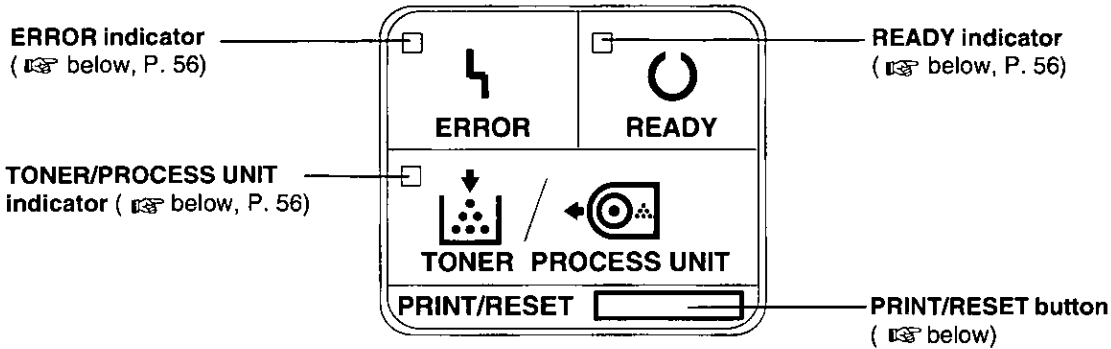

Indicators			Printer status
ERROR	READY	TONER/PROCESS UNIT	
■*	■*	■*	Warming up
□	■	□	Ready for printing
□	⏏	□	Receiving data, or printing
□	⏏	□	Data remains in the printer
⏏	□	■	Process Unit is not installed
□	□	⏏	Toner empty

- * Three indicators will light one after another.
- : on ⏏ : blinking (fast – with an interval of about 1 second)
- : off ⏏ : blinking (slow – with an interval of about 2.5 seconds)
- For error indication, refer to page 56.

PRINT/RESET button:

PRINT/RESET will execute one of the following functions depending on the status of the printer.

Indicators			Function
ERROR	READY	TONER/PROCESS UNIT	
□	■	□	Print a test page for DOS by pressing this button (< 5 seconds)
□	■	□	Reset the printer by pressing this button until the three indicators are lit
□	⏏	□	Print the remaining data by pressing this button (< 5 seconds)
□	⏏	□	Reset the printer by pressing this button until the three indicators are lit

■ : on □ : off ⏏ : blinking (slow)

Preparation

Printer Stands Installation

- 1 ① Lift the printer by holding its front side and remove the two printer stands by firmly sliding them downward.
- ② Rotate the printer stands 180° and install them into the printer.

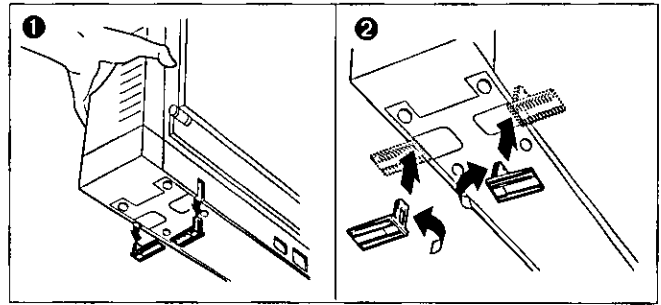

Process Unit Installation

Important:

To prevent any damage to the Process Unit, observe the following precautions.

- Do not touch the green drum surface. Lift the Process Unit by holding the green labeled tabs.
- Do not expose the Process Unit to light for more than 5 minutes, or to direct sunlight.
- Do not keep the Process Unit near dust or dirt.
- Do not place the Process Unit in a high humidity area.

- 1 Open the left cover by gently pulling the cover release tab.

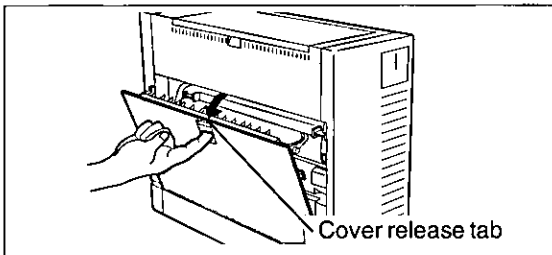

- 2 Remove the Process Unit by grasping the green labeled tabs and pulling it toward you.

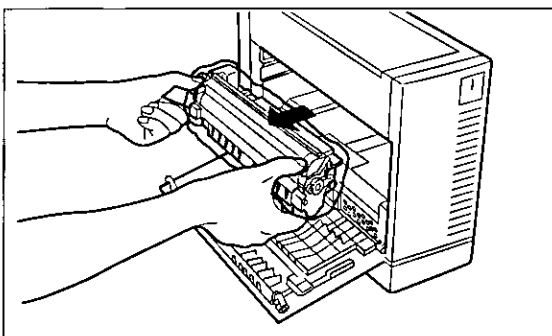

- 3 Open the plastic bag and remove the Process Unit.

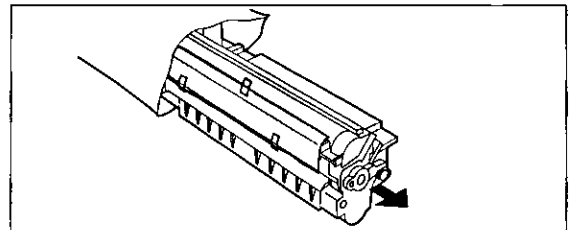

- 4 ① Remove the sealing film.
② Remove the protective sheet.
③ Remove the tapes.

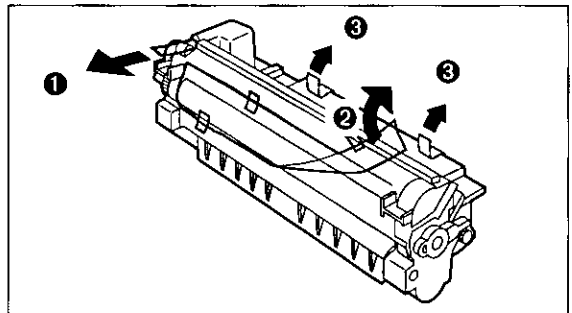

- 5 Install the Process Unit by grasping the green labeled tabs and pushing it firmly into the printer.

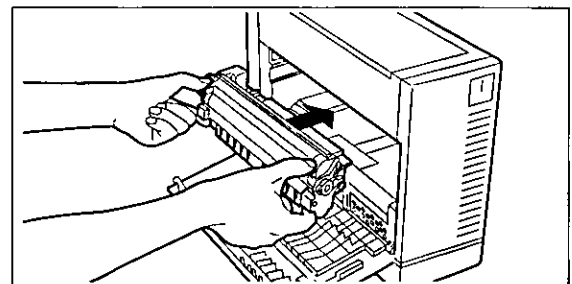

(continued)

Setup

- 6 Close the left cover.

Notes:

- PLEASE DO NOT THROW AWAY THE PACKING MATERIALS. YOU MAY NEED THEM TO SHIP OR TRANSPORT THE PRINTER.
- TO PROVIDE OPTIMUM PRINT QUALITY THE UNIT MUST BE UPRIGHT AND KEPT LEVEL AT ALL TIMES.

Connecting the Printer and Power On

This printer is equipped with a bidirectional parallel interface. If you do not have an interface cable, you will need to purchase one from your local computer store or dealer.

- 1 Turn OFF the printer and computer.

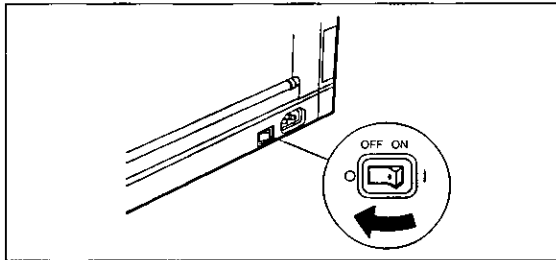

- 2 Plug one end of the cable into the parallel interface connector of the printer. Snap the clips into place.

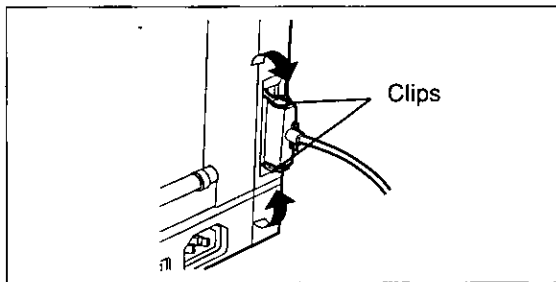

If the cable has a frame ground wire, connect it to the frame ground terminal.

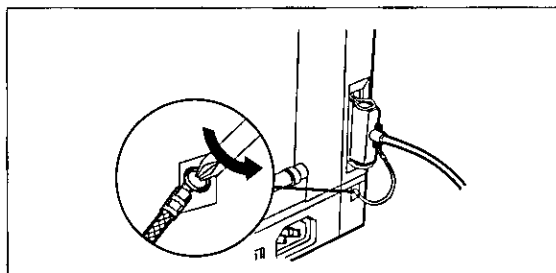

Note:

- Be sure to use only a shielded cable. The printer will not operate properly if any of the pins are not connected.

- 3 Plug the other end of the cable into the connector at the computer.

Notes:

- The actual connector on the computer may differ depending on the manufacturer of the computer.
- If the cable is connected to PC via printer buffer or selector, the printer may not print.

- 4 Plug one end of the power cord into the printer's power connector plug.

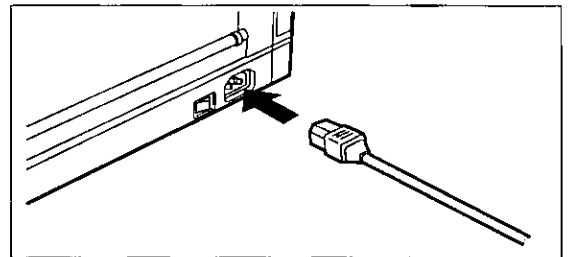

- 5 Plug the other end of the power cord into a 3-prong AC wall socket.

- 6 Turn ON the printer and computer power switches.

- 7 The printer is warming up. The READY indicator, the ERROR indicator and TONER/PROCESS UNIT indicator start lighting one after another.

- 8 The printer is ready for printing. The READY indicator is on.

Loading Paper/Envelopes (Labels, Transparencies)

Loading Paper

This printer has a multi-purpose paper tray. The paper size selected through the GDI Mode (P. 34) or PCL Mode (P. 41) and your software application should also match the size of the paper in the paper tray for proper print alignment.

- 1 **Open the output tray (top cover).**
- 2 **Extend the paper support by sliding it upward.**

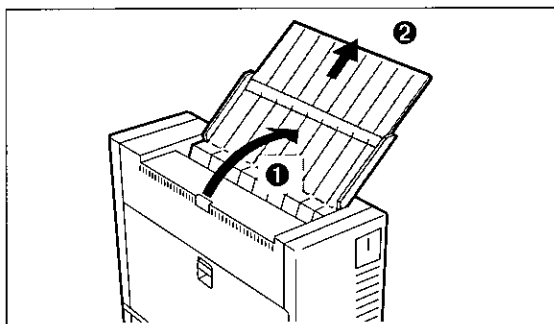

- 2 **Open the paper tray.**

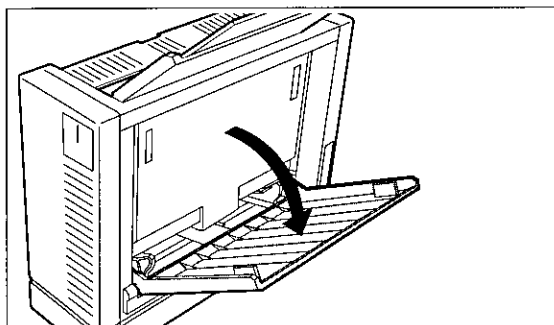

- 3 **Separate the paper guides to the approximate width of your paper.**
Refer to the size indicators above the paper guides for accurate paper width.

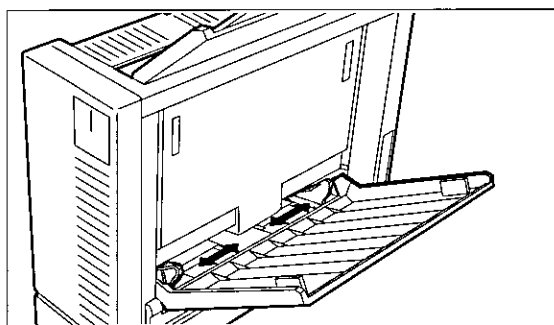

- 4 **Fan the stack of paper and tap it on a level surface to avoid paper jams or skewed printing.**

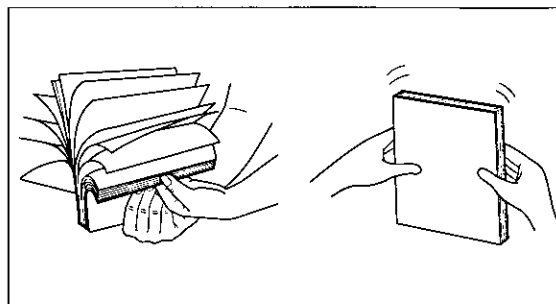

Note:

- You may load up to 100 sheets of 75 g/m² (20 lbs.) paper in the paper tray.

- 5 **Place the paper in the paper tray properly and adjust the paper guides to your paper size.**
The height of paper should not exceed the limit mark on the paper guide, or it may cause a paper jam.

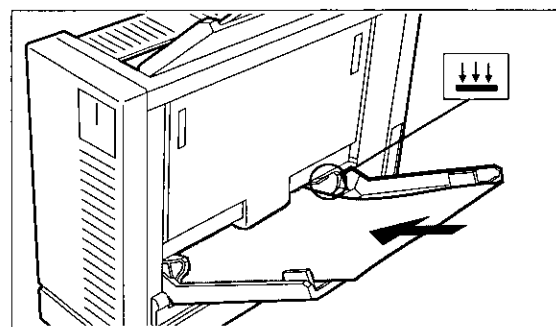

(continued)

Setup

Notes:

- If the paper guides are not adjusted properly, your printout may be skewed.
- Do not load paper of different types or thickness in the paper tray at one time; this may cause a paper jam.
- When you want to add more paper to the paper tray, you must first remove the remaining paper from the tray and then place the entire stack of paper into the tray.
- Make sure you load the paper with the print side up. Most paper has instructions recommending the side to be printed first. When using 60 g/m² (16 lbs.) paper, always load the paper with the “non-curl side” up rather than following instructions on the paper package.
- For more detailed information on paper, refer to “Paper Specifications” (P. 61).
- Do not allow more than 50 sheets [75 g/m² (20 lbs.)] to accumulate in the output tray. This may cause a paper jam.

Loading Envelopes (Labels, Transparencies)

You may load either 30 sheets of labels, 30 transparencies, or up to 10 envelopes in the paper tray. You can use Business Commercial #10, Monarch, International DL and International C5 envelopes. For more detailed information on Envelopes, refer to “Envelope Specifications” (P. 63).

Notes:

- Make sure that all seams are properly sealed before loading envelopes.
- The envelopes must be loaded with the shorter side first to avoid a paper jam.
- When installing envelopes, the flaps should be face down.
- To print lengthwise on the envelope (along the longer side), set the printing mode to landscape (P. 34, 41).

1 Perform steps 1 and 2 on page 15.

2 Adjust the paper guides to the approximate width of your envelope.

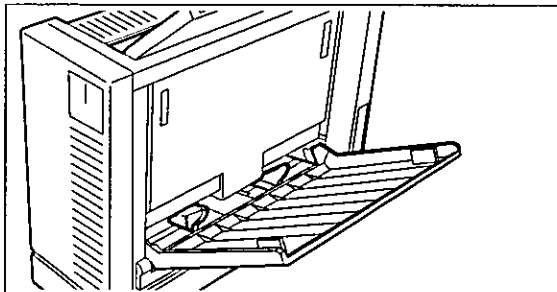

3 Place the envelopes in the paper tray with the sides to be printed facing up. Position them between the paper guides, and adjust the guides until you feel resistance.

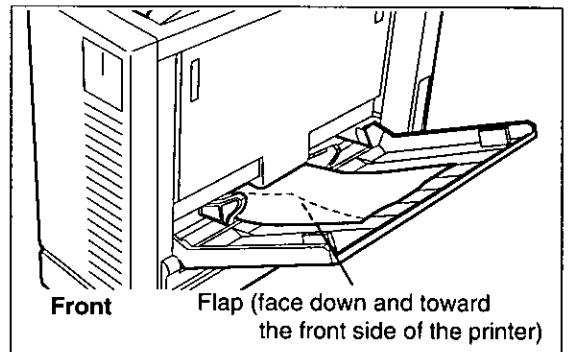

4 Verify that your envelope matches the paper size set through the GDI Mode (P. 34) or PCL Mode (P. 41) and software application for proper print alignment.

KX-P6500 for Workgroups Configuration Overview

KX-P6500 for Workgroups provides three software configuration options depending on how you intend to use your printer:

- Personal
- Server
- Client

Whether you use the printer in a network configuration or as a non-network printer, your configuration will provide all the same print modes and printer features. Network and resource* sharing related features are not available in the "Personal" configuration.

* A resource is a piece of data, software application, or hardware that can be accessed and used by multiple users or system components. A resource provides a service.

Personal Configuration Overview

The Personal configuration is for users that are not connected to a network, or will not use the printer as a shared network resource. If at some point, you choose to add network capabilities to your PC or you choose to allow the printer to be a shared network resource, you will have to re-install the KX-P6500 for Workgroups software (P. 20) and select the Server User Type option (P. 20). However, note the hardware requirements for Server PCs (P. 10) to ensure that you have the minimum hardware necessary to install as a Server.

Network Configuration Overview

Microsoft Windows for Workgroups or Windows 95 is designed as a peer-to-peer network. That is, each connected PC is a peer to every other connected PC in the workgroup. This peer approach means that no PC in the workgroup acts as a network administrator. The PC that has the printer connected to it performs some additional functions not needed by PCs without a connected printer. Therefore, we have adopted the Client/Server terminology to differentiate between those PCs that have a printer connected to them and those PCs that do not have a connected printer. A Server is that peer with a connected and shared printer. A Client is a peer using a printer connected to a Server.

Note:

- For a peer to access another peer's printer, both peers must have KX-P6500 for Workgroups software (P. 20) installed and selected in their Windows printer list.
- A maximum of three PCs on the network can use KX-P6500 or KX-P6100 printer. If your network has more than three PCs, the KX-PNW1 option (P. 58) is needed. The KX-PNW1 can support a maximum of 25 PCs.

Server Configuration

The Server is the peer in the workgroup that has a printer connected to it. At installation, the KX-P6500 Setup program asks if you wish to configure the PC as a Server or a Client. You must configure the PC with the attached printer as a Server.

Note:

- If you previously installed and configured your PC as a Client, you must reinstall your printer as a Server (P. 20).

Any Server in the workgroup with KX-P6500 for Workgroups software (P. 20) installed can be effectively both a Server and a Client. As a Server, that PC shares the connected printer with other peers in the workgroup. However, when that server opts to print to a printer supported by another Server, that PC is acting as a Client to the other Server.

Setup

Client Configuration

The Client is a peer in the workgroup that wants to print to another peer's printer.

Network Configuration Example

As you can see in the following figure, there are two PCs that have attached printers: Peer A with Printer A and Peer D with Printer D. If Peer B chooses to print to Printer A, Peer B is the Client and Peer A is the Server for that print job. If Peer A wants to print to Printer D, Peer A becomes a Client to Peer D, but Peer A remains the Server for Peer B's print job.

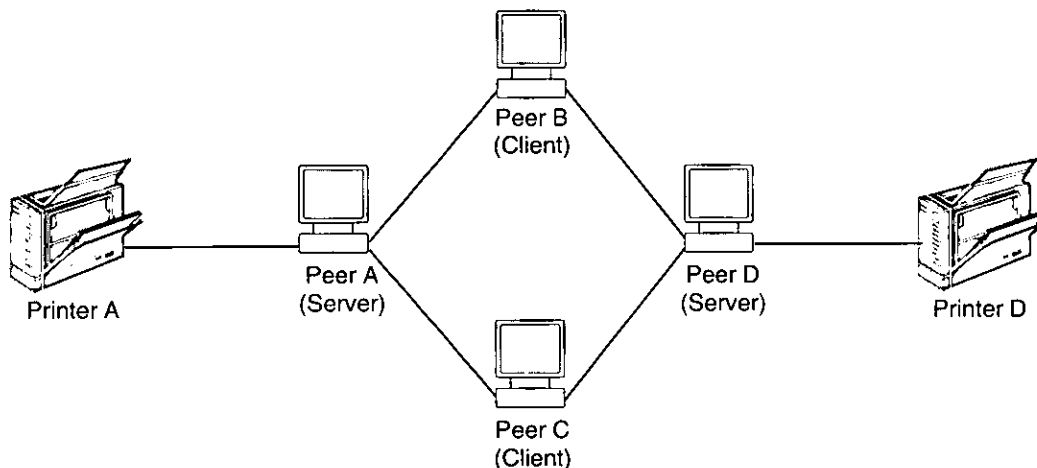

Installing the Network Connection on Your PC

This section is for users that share the KX-P6500 printer on a network or for Clients that will use a shared printer. Skip this section if you plan to install the Personal configuration option. To use the KX-P6500 in the network, the Windows for Workgroups or Windows 95 network has been constructed in advance.

To install a network connection on your PC, you need a network card adapter (either an internal bus card, an external PCMCIA card, or a parallel port version) and network software. Refer to your Microsoft documentation and network interface card or network adapter documentation for specific details regarding network connectivity and configuration. Using Microsoft Windows for Workgroups or Windows 95 will provide you the network connectivity necessary to use the KX-P6500. Refer to the steps below to install a network connection on your PC.

Step	Action	Comment
1	Setup a peer-to-peer Windows for Workgroups or Windows 95 environment.	Refer to your Windows for Workgroups or Windows 95 and network adapter documentation.
2	Enable the peer-to-peer network by ensuring that peers can communicate via the Mail and Chat applications.	This step is recommended to ensure that your network is operational and all connected network peers can communicate.
3	Set Virtual Memory.	Minimum virtual memory of 12 MB is required (see P. 19). For Windows 3.1 or Windows for Workgroups 3.11, permanent memory rather than temporary memory is recommended.

Allocating Virtual Memory

For Windows 3.1 or Windows for Workgroups 3.11

The KX-P6500 for Workgroups software requires a minimum of 12 MB of virtual memory for Personal, Client and Server configurations.

To change the virtual memory, follow the instructions below. For more information on virtual memory, refer to the Optimizing Windows section in the Microsoft Windows 3.1 User's Guide.

- 1 Double click the *Main* icon from the Program Manager screen.
- 2 Double click the *Control Panel* icon.
- 3 Double click the *386 Enhanced* icon.
- 4 Click .
- 5 If the size shown in the Virtual Memory dialog box is less than 12,000 KB, then click .
Otherwise click to exit the dialog box.
- 6 Select the Type "Permanent" in the New Swapfile Settings box.

- 7 Increase the New size in the New Swapfile Settings box to at least 12,000 KB.

Note:

- If you cannot increase the New size to the desired figure, then select the Type "Temporary" and set the virtual memory size.

- 8 Click .
- 9 Click .
- 10 Click to make the setting effective.

For Windows 95

It is recommended that you let Windows manage your virtual memory. However, if you need to manually increase the virtual memory, follow the instructions below.

- 1 Click the button, move the pointer to "Settings" and click "Control Panel".
- 2 Double click the *System* icon.
"System Properties" window will be displayed.
- 3 Click the "Performance" tab.
- 4 Click .
- 5 Click "Let me specify my own virtual memory settings" button.



- 6 Increase the Minimum setting to at least 12.
- 7 Click .
- 8 Click .
- 9 Click .
- 10 Click to restart Windows.

Using the Printer in Windows

Installing the KX-P6500 for Workgroups Software

The KX-P6500 for Workgroups software installation analyzes your system configuration, installs the software, and makes the necessary changes to Windows startup files. Installation can be performed from the installation disks, the Windows for Workgroups or Windows 95 network. Once a Server has installed the KX-P6500 for Workgroups software on the Server PC, Clients can install Client software on the Client PC from disk #1 and then from across the network. This installation proceeds faster than disk installation.

The KX-P6500 for Workgroups software installations will create and let you use the following.

- KX-P6500 Console ( P. 27) in the KX-P6500 Tools window
 - includes printer drivers for Windows 3.1 and Windows for Workgroups 3.11, or printer drivers for Windows 95
 - enables you to setup the printer in Windows
- KX-P6500 Control Panel ( P. 44)
 - enables you to setup the printer in MS-DOS

Notes:

- If you wish to discontinue installing the software during installation, first complete the installation procedure, then use the Uninstall Utility to remove ( P. 24).
- Printer driver disks 2 of 4, 3 of 4 and 4 of 4 are the same and used for both Windows 95 and Windows 3.1.

Installing the Windows 3.1 Printer Driver & Utilities

- 1** To start Windows in the 386 Enhanced Mode, type WIN at the DOS prompt and press **Enter** .
- 2** Insert the Windows 3.1 Printer Driver & Utilities disk 1 of 4 (#1) into disk drive A.
- 3** From the Program Manager, click "File". Then click the "Run..." option.
- 4** At the prompt, type A:\SETUP and click **OK** .
- 5A** If you are installing the software on a server/personal, click **Printer On** .
- 5B** If you are installing the software on a client, click **No Printer** .
- 6** The Setup Program has determined the following user configuration. If necessary, make any changes to this window.

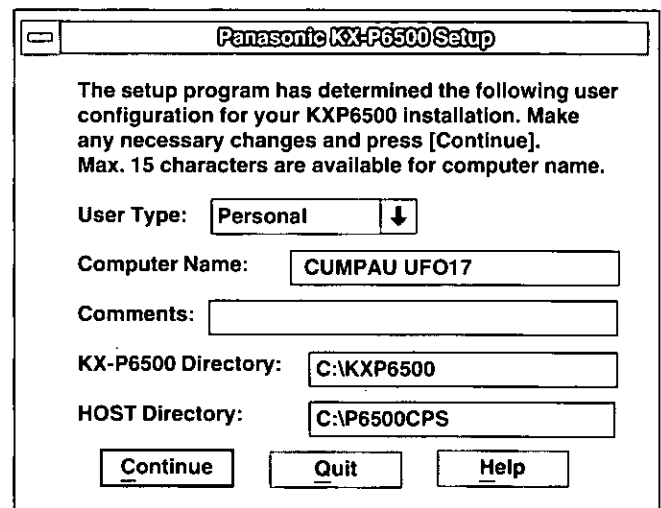

Panasonic KX-P6500 Setup

The setup program has determined the following user configuration for your KXP6500 installation. Make any necessary changes and press [Continue]. Max. 15 characters are available for computer name.

User Type: ↓

Computer Name:

Comments:

KX-P6500 Directory:

HOST Directory:

- **User Type:** Select personal, Client or Server depending on your computer configuration.
- **Computer Name:** Type in the name of the computer network or computer name, up to 15 characters, in the Computer Name field.
- **Comments:** Type in any comments in the comments field. For instance, software version No. or your name, etc.
- **KX-P6500 Directory:** If you wish to install the KX-P6500 for Workgroups software for Windows on another drive and/or directory, type the letter of the drive and/or directory name in the KX-P6500 Directory field.

Using the Printer in Windows

- **Host Directory:** If you wish to install the Control Panel Software for DOS on another drive and/or directory, type the letter of the drive and/or directory name in the Host Directory field.

7 Click **Continue**.

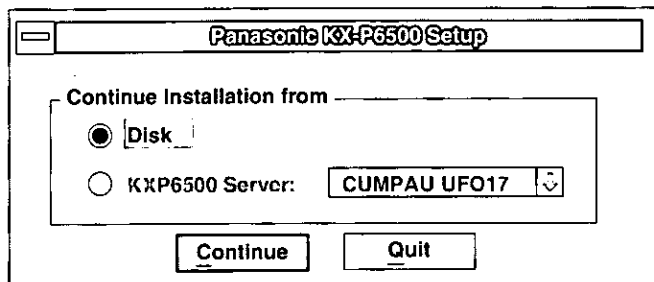

8A If you wish to install the software from disks, proceed to step 9.

8B If you wish to install the software from KX-P6500 Server, click on the "KXP6500 Server" button and select the server from which you wish to continue installation.

- Make sure the KX-P6500 for Workgroups or Windows 95 software has been installed on the Server PC.

Note:

- If the Client's Windows type (Windows for Workgroups 3.11 or Windows 95) is different from that of Server's, the software can not be installed on a Client from the Server. Install the software from disks.

9 Click **Continue**.

10 The Setup Program has determined the following printer configuration.

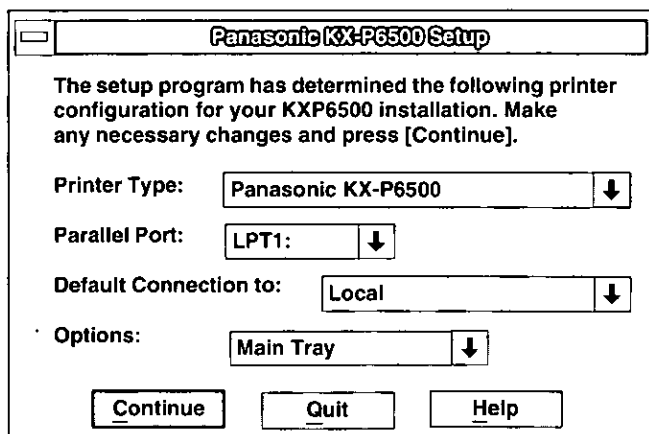

- If necessary, make any changes to this window.

11 Click **Continue**.

12 Follow the instructions on the screen.

13 Remove the inserted disk.

14 Click **Restart Now** to restart Windows.

Installing the Windows 95 Printer Driver & Utilities

Installing the Software on a Server/Personal

1 Turn the Printer on.

Confirm the READY indicator is lit.

2 Start computer using Windows 95.

"New Hardware Found" window will be displayed.

- If the printer is not READY, "New Hardware Found" window will not be displayed. After the printer is READY, turn the computer off then on again.

3 Click **OK**.

"Install From Disk" window will be displayed.

4 Insert Windows 95 Printer Driver & Utilities disk 1 of 4 (#1) into disk drive A.

5 Click **OK**.

First, the "Panasonic KX-P6500 for Workgroups" window appears, and then the "Panasonic KX-P6500 Setup" window will appear.

6 Perform steps 5~14 of "Installing the Windows 3.1 Printer Driver & Utilities" on pages 20 and 21 to complete the installation.

(continued)

Using the Printer in Windows

Notes:

- You can also install the Windows 95 Printer Driver & Utilities using the Add Printer icon of Windows 95. To do so, refer to the instructions on the label of the Windows 95 Printer Driver & Utilities disk 1 of 4.
- The Installation window lies behind other windows. To bring the installation window to the front, close other windows.

Installing the Software on a Client

- 1 Start computer using Windows 95.
- 2 Insert the Windows 95 Printer Driver & Utilities disk 1 of 4 (#1) into disk drive A.
- 3 Click the **Start** button, move the pointer to "Settings" and click "Printers".
- 4 Double click the *Add Printer* icon. "Add Printer Wizard" window will be displayed.
- 5 Click **Next>**.
- 6 Click "Network printer".
- 7 Click **Next>**.
- 8 Type the network path or the queue name of your printer in the Network path or queue name box.
- 9 Click **Next>**.

- 10 Click **Have Disk..**. "Install From Disk" window will be displayed.

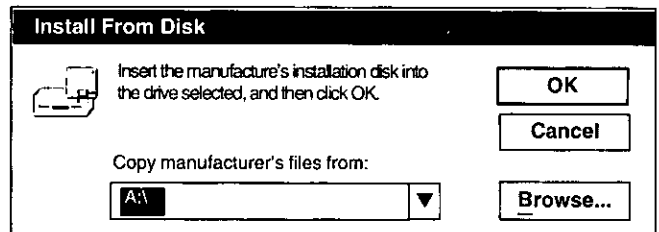

- 11 Click **OK**.

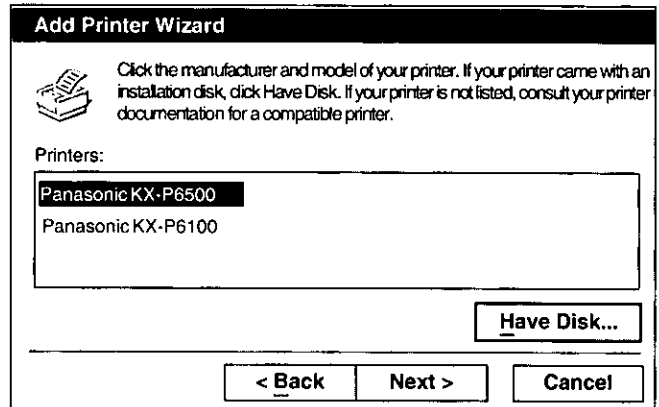

- 12 Click "Panasonic KX-P6500" in the Printers box.
- 13 Click **Next>** twice.
- 14 Click **Finish**. First, the "Panasonic KX-P6500 for Workgroups" window appears, and then the "Panasonic KX-P6500 Setup" window will appear.
- 15 Perform steps 5-14 of "Installing the Windows 3.1 Printer Driver & Utilities" on pages 20 and 21 to complete the installation.

Note:

- The Installation window lies behind other windows. To bring the installation window to the front, close other windows.

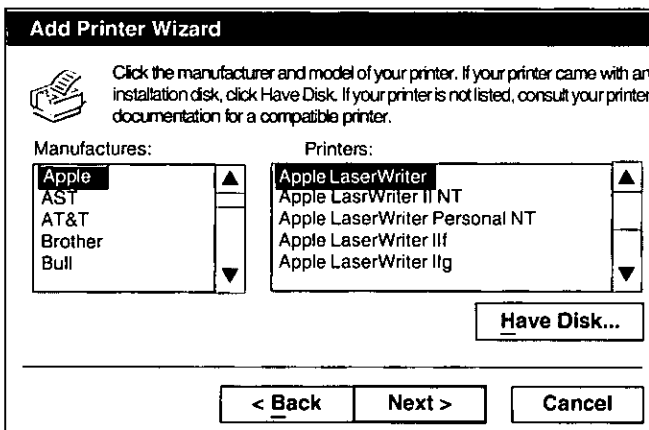

Printer Resource Sharing

If during installation you have selected Personal or Client, skip this section.

The server printer must be shared and the client must be one of the authorized users of the server before a Client can print to the KX-P6500 printer.

To share a printer resource the Server must perform the following steps:

- 1** From the Program Manager, double click the *Panasonic KX-P6500 Tools* icon.
- 2** Double click the *KX-P6500 Console* icon.
- 3** Click the "Control Panel" tab or "Network" menu.
- 4** Click  or "Share Printer".
- 5** Click on the item(s) that you want to share. (i.e. GDI and PCL)
- 6** Click **Clients**.

7A To Remove unauthorized client(s):

- Select clients from the "Share with" list box, then select the REMOVE button. (Select Remove All will unauthorize all current connected clients.)

7B To add authorized client(s):

- Select clients from the "Choose from" list box, then select the Add button. (Select Add All will authorize all current and thereafter connected clients to share the printer.)

- 8** Click .

Printer sharing will be established automatically every time Windows starts up.

Stop Sharing the Printer Resource

To stop sharing the KX-P6500 printer resource, perform the following steps:

- 1** Perform steps 1 to 4 of "Printer Resource Sharing" above.
- 2** Click off the item(s) that you want to stop sharing.
- 3** Click .

Connecting a Client PC to a Shared Printer

Before a Client can print, the Client must connect to a shared printer resource. To connect to a shared printer resource, the Client must perform the following steps:

- 1** From the Program Manager, double click the *Panasonic KX-P6500 Tools* icon.
- 2** Double click the *KX-P6500 Console* icon.
- 3** Click the "Control Panel" tab or "Network" menu.
- 4** Click  or "Connect to ...".

Using the Printer in Windows

5 Click on the "Remote Printer on" button.

6 Select a Server you want to connect to.

7 The selected server can be used for all your print modes by clicking on "Server of All Virtual Printer" box.

8 Click **OK**.

Testing the Printer

To verify that the software installation was successful, perform the following steps:

1 If you are performing a test print on a personal/server, be sure the printer's cable is attached to the printer parallel port that was selected during installation.

— or —

If you are performing a test print on client, make sure the server has been selected for All Print Mode. ( Steps 1~8 above)

2 Make sure the printer is ready and paper is loaded.

3 From the Program Manager double click the *Panasonic KX-P6500 Tools* icon.

4 Double click the *KX-P6500 Console* icon.

5 Click the "Control Panel" tab.

6 Click the  (Print Test Page) button.

The Print Test Page screen is displayed.

7 Select "Test Page" or "Configuration Page" or both.

8 Click **OK**.

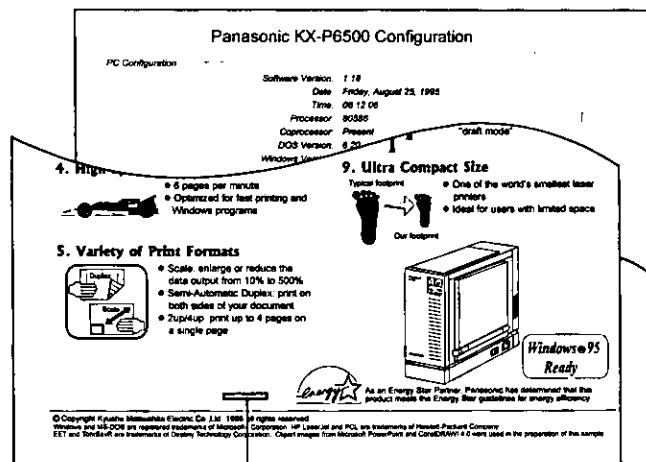

EET Test pattern ( P. 32)

Note:

- It is recommended that you close all active Windows applications before printing a test page, and make sure that there are no print jobs paused in the KX-P6500 Console ( P. 27). Otherwise, test printing may not be possible.

Removing the KX-P6500 for Workgroups Software

If you need to remove the KX-P6500 for Workgroups software, perform the following.

1 From the Program Manager, double click the *Panasonic KX-P6500 Tools* icon.

2 Double click the *Uninstall Utility* icon.

3 Click **OK**.

4 The one remaining file (delete.exe) and directory must be manually removed by the user after uninstallation.

Print Modes

Print Mode Selections

You can select either of the two print modes, GDI Mode (P. 34) or PCL Mode (P. 41), according to your requirements. If you cannot determine which print mode is best suited for your printing applications under Windows, we recommend you always use GDI Mode first.

GDI Mode has the following features:

- faster printing, as much as five times faster for some files
- manual duplex printing (P. 36)
- 1st page on top (reverse order printing) (P. 35)
- overlay (P. 36)

PCL Mode is effective in the following cases:

- when you want to print a file created with an MS-DOS application
- when you want to print a PCL format file
- when you want to print an ASCII formatted file
- when you want to print complex graphic files that Windows may not display well

Automatic Emulation Switching

When you send a print job to the printer, the printer will determine which language is being used by the print job, and the printer's personality will automatically switch to that language (GDI or PCL). If the personality is switched, the printer's memory will be reconfigured and all user-downloaded data will be lost.

When the Printer Configuration is Changed

When the printer is changed to KX-P6500/KX-P6100 (P. 59), you must select the "Local Printer Change" in the Settings menu in the KX-P6500 Console window (P. 27, 33). When the RAM Expansion Board option (P. 58) is installed in the printer, Windows must be restarted.

Printing Documents

Printing From a Windows Application

Once you have selected your print mode (GDI or PCL emulation *), just print from your Windows application as you would to any other printer.

* Emulation means to operate like another printer.

Printing From a DOS Application Within Windows

If the KX-P6500 is in PCL Mode, it can print a DOS application file as follows: Double click the MS-DOS icon in the Main window, start the DOS application and print a file. We recommend that you print a DOS application file after exiting Windows because some applications may not allow you to print properly under Windows.

Using the Printer in Windows

Changing the Print Mode

There are three methods of changing the print mode between GDI Mode and PCL Mode (see A, B, and C).

A: From an Application

Most of the popular Windows applications allow you to change GDI Mode/PCL Mode. For example, to change the mode in Microsoft Write, perform the following.

- 1 Select "Print Setup..." under the File Menu.

The Print Setup window will be displayed.

- 2 Select the desired print mode.

To change to GDI Mode or PCL Mode, select "Panasonic KX-P6500 GDI on KXPGDI" or "Panasonic KX-P6500 PCL on KXPPCL".

- 3 Click **OK**.

B: From the Control Panel in Windows

- 1 Double click the *Main* icon in the Program Manager to display the Main window.

- 2 Double click the *Control Panel* icon in the Main window.

- 3 Double click the *Printers* icon in the Control Panel window.

- 4 Select the desired print mode.

To change to GDI Mode or PCL Mode, select "Panasonic KX-P6500 GDI on KXPGDI" or "Panasonic KX-P6500 PCL on KXPPCL".

- 5 Click **Set As Default Printer**.

The print mode you selected in step 4 appears in the Default Printer field.

- 6 Click **Close**.

C: From the Control Panel Tab of the KX-P6500 Console

- 1 Double click the *Panasonic KX-P6500 Tools* icon in the Program Manager to display the Panasonic KX-P6500 Tools window.

- 2 Double click the *KX-P6500 Console* icon.

- 3 Click the "Control Panel" tab in the KX-P6500 Console window.

- 4 Click the Printer list box.

- 5 Select the desired print mode.

To change to GDI Mode or PCL Mode, select "GDI>> Panasonic KX-P6500 GDI" or "PCL>> Panasonic KX-P6500 PCL".

- 6 Click **Set As Default**.

- 7 Minimize the KX-P6500 Console.

KX-P6500 Console

The KX-P6500 Console provides a single access point to the four major program screens. The purpose of the KX-P6500 Console is to provide an easy means to configure the KX-P6500 printer and to monitor and control print jobs.

To display the KX-P6500 Console window, perform the following.

- 1 From the Program Manager double click the *Panasonic KX-P6500 Tools* icon.

The Panasonic KX-P6500 Tools window will be displayed.

- 2 Double click the *KX-P6500 Console* icon.

The KX-P6500 Console window will be displayed.

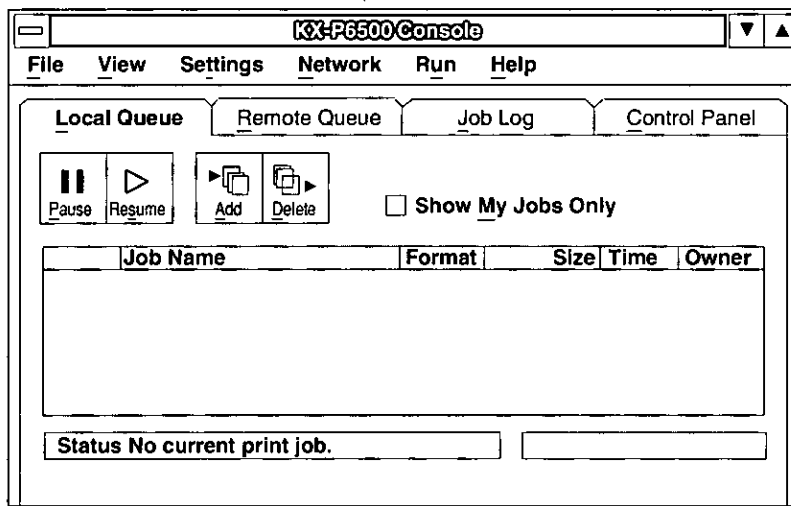

Each of the four major program features can be viewed by clicking the tab under the window menu bar. The four tabs are:

- Control Panel
- Local Queue
- Remote Queue
- Job Log

For descriptions of the menu bar items, refer to “KX-P6500 Console Menu Items” on page 32.

Control Panel

The Control Panel provides the mechanism to configure and control the printer. Figure A (P. 28) shows the Control Panel tab of the KX-P6500 Console. The Control Panel is divided into six button categories, the Printer information and printer selection display. The Printer group item presents the currently selected printer and provides a list of additional printer selections. The printer selections applicable to your printer are:

- Panasonic KX-P6500 GDI
- Panasonic KX-P6500 PCL

Using the Printer in Windows

To display the Control Panel features, click the "Control Panel" tab in the KX-P6500 Console window.

Figure A

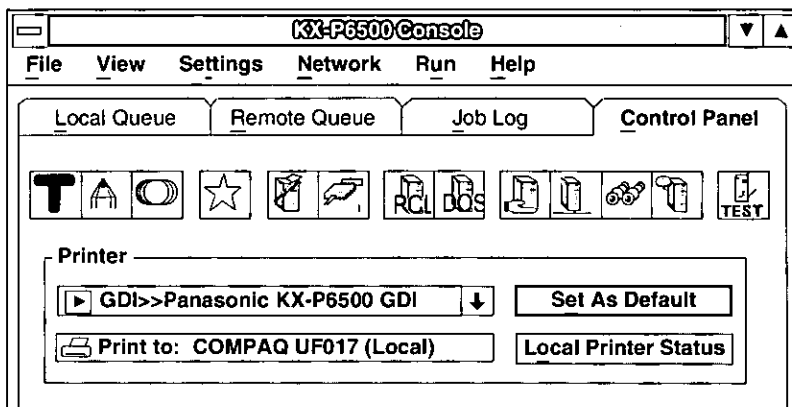

Use the list bar to highlight the print mode you want to use. Then, to apply the selected printer, click **Set As Default**. You can also request the current printer status through the **Local Printer Status**.

The following table provides a brief description of the Control Panel buttons and refers you to the page number that provides detailed information about the available features.

Icon	Description	Page
Toner Saving	Allows you to choose from three toner saving modes: light, medium, and dark. The off selection is for regular print toner use. Toner saving modes can significantly reduce toner costs by extending the life of your toner cartridge.	32
EET	Smooths the jagged edges of your line art and text characters.	32
Density	Provides five shades of density. The default is 3.	32
Power Saving	Identifies the wait time between last printer use and start of printer power saving.	32
Printer Setup	Used to configure the printer.	33
Connect Port	Identifies the port where your printer is connected, such as LPT1.	33
PCL Control Panel	Displays the PCL Control Panel Menu.	33
DOS Printing Options	Allows you to configure how DOS print job within Windows printing is to be processed.	33
Share Printer	Allows you to share the printer with Clients.	33
Connect to	Allows you to connect to a shared printer.	33
Client Monitor	Allows you to view the Clients.	33
Printer Status	Allows you to select whether you want the Printer Status window to display when an error occurs.	43
Print Test Page	Allows you to print GDI 600 dpi test pages and configuration page.	24

Local Queue

The Local Queue is used to review the status of your queued print jobs. For Servers, all pending print jobs are local to the Server. For Clients, the Local Queue represents print jobs that have been queued to a remote Server but are not yet transferred to that remote Server.

To display the Local Queue features, click the "Local Queue" tab in the KX-P6500 Console window.

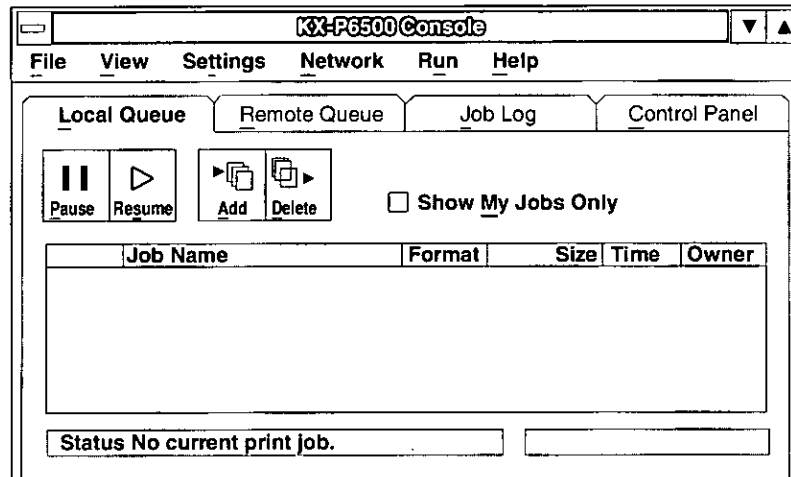

The Local Queue displays:

- the print job name
- the format of the print job (GDI, PCL)
- the size of the print job in bytes
- the time the job was sent to the queue
- the owner of the print job

The job owner category is primarily applicable to the Server.

The Local Queue displays the status of the job currently being printed. For Clients, this status will display only when the Client's print jobs are being printed.

Note:

- Print job in the Local Queue will be displayed only when "Use Panasonic KX-P6500 Print Manager" is selected in the Panasonic KX-P6500 GDI window (P. 35).

Changing the Order of Print Jobs

Both Servers and Clients support drag-and-drop jobs within the Local Queue to change the job order in the print queue. Drag-and-drop is available for jobs that have not started printing. To drag-and-drop, perform the following steps:

- 1** Place the mouse cursor at the beginning of the print job you want to select.
- 2** Press and hold the left mouse button.
- 3** While holding the left mouse button down, move the mouse.
- 4** Move the mouse to the last print job you want to select.
- 5** Release the left mouse button.
The print job will remain highlighted.
- 6** Return the mouse cursor to the beginning of the selection.

As you position the mouse, print jobs will be highlighted.

Note the I-bar cursor turns into an arrow when the cursor is in the highlighted area.

Using the Printer in Windows

7 Depress and hold the left mouse button.

8 While holding the left mouse button down, move the mouse arrow to the place you wish to drop the selected print job(s).

9 Release the mouse button.

The following table provides a brief description of the Local Queue button icons.

Icon	Description
	Allows you to pause printing.
▶	Allows you to resume printing.
▶ [document icon]	Allows you to add a print job to the print queue.
[document icon] ▶	Allows you to delete the highlighted print job from the print queue.

Remote Queue

The Remote Queue is used to review the status of your queued print jobs at the remote printer. This queue is primarily for Clients to review their print jobs. Clients can select from among the shared printers through the "Show Print Queue for:" list box.

To display the Remote Queue features, click the "Remote Queue" tab in the KX-P6500 Console window.

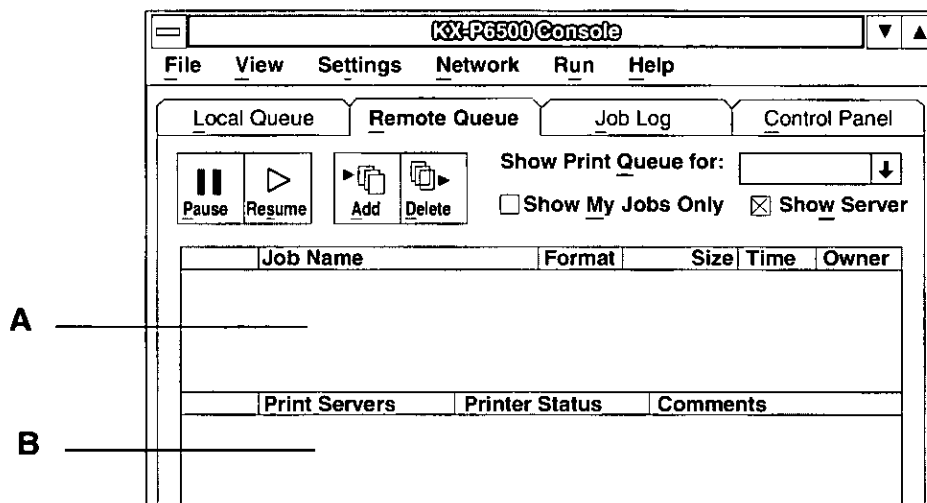

Show Print Queue for:

Allows the Clients to select from among the shared printers. Clicking the list box will show you all available shared printers.

Show My Jobs Only

Clicking on the "Show My Jobs Only" check box will only display your print jobs in box A.

Show Server

Clicking on the "Show Server" check box will display the box B. This box will show you all the servers with their status.

The Remote Queue displays:

- the print job name
- the format of the print job (GDI, PCL)
- the size of the print job in bytes
- the time the job was sent to the queue
- the owner of the print job

The job owner category is primarily applicable to the Server. The drag-and-drop (reordering the print jobs) feature is not available in the Remote Queue.

The following table provides a brief description of the Remote Queue button icons. The Remote Queue displays the status of the job currently being printed.

Icon	Description
	Allows you to pause printing.
▶	Allows you to resume printing.
▶ [stack of papers]	Allows you to add a print job to the print queue.
[stack of papers] ▶	Allows you to delete the highlighted print job from the print queue.

Job Log

The Job Log provides a historical log of the last 10 jobs queued for print. To display the log of the last 10 jobs, click the "Job Log" tab in the KX-P6500 Console window.

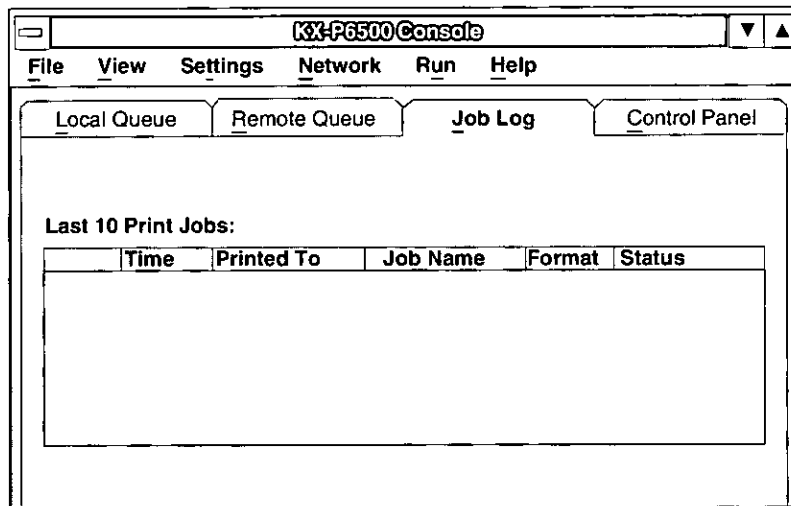

The Job Log displays:

- the time the job was printed
- the Server name
- the job name
- the format of the print job (GDI, PCL)
- print result

The Job Log is more useful for Clients in workgroup environments, where there are multiple printers supporting differing printer characteristics.

Using the Printer in Windows

KX-P6500 Console Menu Items

The KX-P6500 for Workgroups software provides the standard Windows menu items which are available in most Windows applications, as well as application-specific menu items. Some of the menu items match the buttons available on one of the tabbed displays. However, there are some printer functions that can be accessed only through the pull-down menu, such as the setting of print priority.

File

The File pull-down menu provides selection to exit your application. This menu also provides selections to pause or resume printing and add or delete a document to and from the queue.

View

The View pull-down menu allows you to define different ways to display the print queues. You can view a list of queued print jobs, define the time stamp, or show a particular print queue.

Settings

The Settings pull-down menu allows you to define the default settings for many of the following printer features.

Toner Saving Mode

With Toner Saving Mode turned on, your printer will reduce the amount of toner used to print. Black areas and text are replaced by a light gray shading.

- Light Text and objects on the page have a black outline along their left edge.
- Medium Text and objects on the page have a black outline along left and right edges.
- Dark Text and objects on the page have a black outline along all edges. This setting is recommended over Light and Medium if you expect to fax or photocopy the document.
- Off This is the default setting and is recommended for the highest print quality.

EET (Edge Enhancement Technology)

With EET turned on, the KX-P6500 will smooth the jagged edges of text and line art, giving the output a very high quality appearance. There are three settings: **Light**, **Medium**, and **Dark**. The factory default setting is Medium. If the EET setting is too dark, the edges appear to bulge.

The demo page of the test print (P. 24) has an Edge Enhancement test block. As a general guideline, select the EET setting so as to make this block look like a uniform gray block as shown in Figure 2.

If there are white vertical lines in the test print (Figure 1), set the EET to a darker setting. If there are dark vertical lines in the test print (Figure 3), set the EET to a lighter setting.

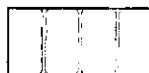

Figure 1



Figure 2



Figure 3

Note:

- The Density settings interact with EET. When you change the Density, readjust the EET setting.

Density

The Density setting allows you to define the darkness of the dots placed on the paper. There are five settings: Level 1, 2, 3, 4, and 5.

Power Saving Mode

With Power Saving Mode turned on, you can save energy by instructing your printer to enter a low power consumption mode when it is idle for 15 minutes.

For USA: To conserve energy and reduce operating cost, the printer is equipped with a programmable power save feature. The printer is factory set with the power save feature turned on and programmed to 15 minutes to comply with EPA's Energy Star requirements.

Printer Setup

The Printer Setup displays the primary printer settings and configuration dialogue that also provides advanced setting and features.

Connect Port

The Connect Port lets you select a different parallel port for your printer. You can choose either LPT1, LPT2, or LPT3. Your PC hardware configuration may limit your individual options.

PCL Control Panel

The PCL Control Panel displays the PCL Control Panel window (P. 42). This control panel provides configuration options for PCL printing from MS-DOS applications printed from the MS-DOS icon command line under Windows.

This setting is effective only when the "Spool as PCL 4.5" has been selected in the DOS Printing Option window. See below.

DOS Printing Options

The DOS Printing Options provides print emulation options for DOS printing. You can select "Spool as PCL 4.5" or "Direct to Port" in the Printing Mode list box.

Spool as PCL 4.5: makes the PCL Control Panel settings effective.

Direct to Port: makes the DOS application's settings effective.

Some applications may not operate properly if the "Spool as PCL 4.5" has been selected. In that case, select "Direct to Port".

Print Priority

Windows lets you run several applications at the same time. This helps productivity but means you are sharing your PC resources among several activities.

The KX-P6500's priority settings let you control the priority of the printing activity relative to other applications running at the same time.

You can select High, Medium, or Low priority. Printing at high priority produces output faster but may slow down your system more than the other priority settings. On the other hand, printing at lower priority lets your other applications run faster but also means your document will take longer to print.

Local Printer Change

Clicking this selection will search which printer, KX-P6500 or KX-P6100, is connected to serve as a local printer and automatically change the printer driver to the corresponding one.

Network

The Network pull-down menu allows you to share and connect to a network printer and Clients Monitor (if configured as a Server) and change status settings, such as print job notifications.

Share Printer

This selection is only available to Server configured users. When selected it will set the printer as Shared.

Connect to

This selection is available to Client and Server configured users. When selected it will display a list of available printer Servers that can be selected.

Client Monitor

This selection is available to the Server and provides the capability to monitor the print activities of Clients using the printer.

Notify

This selection is available to all users and defines the various status selections and their display options. Selecting "Remote Status Report" allows you to see the server's Printer Status window on the client.

Change Name

This selection is available to all users and allows the user to change the computer name. You must exit and restart Windows before this change takes effect. The new computer name must not exceed 15 characters.

Run

The Run pull-down menu allows you to examine the status of the printer and print a test page.

- The "Close Interpreter" selection can clear the PCL Printer icon after a DOS application has been printed using the KX-P6100 printer.

Using the Printer in Windows

KX-P6500 GDI Mode

You can select the GDI Mode from an application, through the Control Panel's Printer window, or through the Control Panel tab of the KX-P6500 Console window (P. 27). The Panasonic KX-P6500 GDI window lets you select certain settings for your print job.

To display the Panasonic KX-P6500 GDI window, perform the following.

- 1 Double click the *Panasonic KX-P6500 Tools* icon in the Program Manager.

The Panasonic KX-P6500 Tools window is displayed.

- 2 Double click the *KX-P6500 Console* icon.

- 3 Click the "Control Panel" tab.

- 4 Click the Printer list box.

- 5 Select "GDI>> Panasonic KX-P6500 GDI"

- 6 Click "Settings" menu.

- 7 Click "Printer Setup...".

The Panasonic KX-P6500 GDI window is displayed.

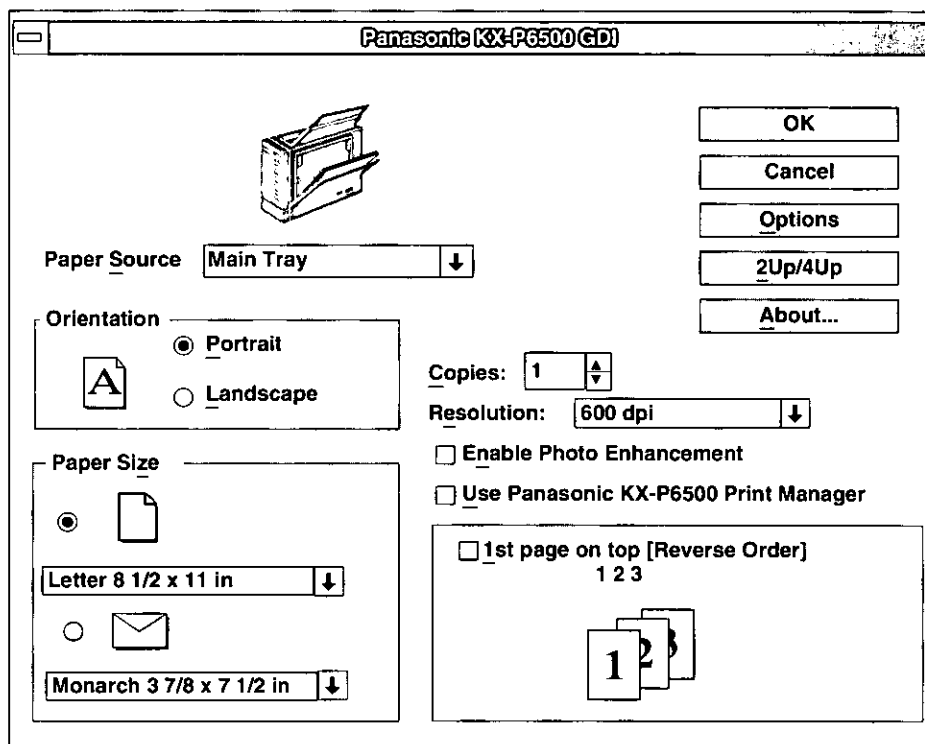

Note:

- Some applications may not allow you to change the settings through the Panasonic KX-P6500 GDI window. In that case, you can change the settings using the Control Panel in Windows as follows:
 1. Perform steps 1-4 of "From the Control Panel in Windows" on P. 26.
 2. Click **Setup** in the Printers window.
 3. Make the desired changes.

Paper Source

Your printer has only one paper source, the Main tray.

Orientation

Choose Portrait (vertical) or Landscape (horizontal).

Paper Size

Allows you to select a different paper size.

Copies

Allows you to determine how many copies of the document will be printed.

Resolution

Your printer provides two resolution settings: 600 × 600 dpi (dots per inch) and 300 × 300 dpi. Higher resolution produces better quality output but requires more time to print a document.

Enable Photo Enhancement

Selecting "Enable Photo Enhancement" will improve the quality of the image output. However, by enabling photo enhancement the KX-P6500 will require more time to print a document.





An overrun situation has occurred. To print the image with Photo Enhancement On, reset the print resolution to 300 dpi. To print in 600 dpi with Photo Enhancement On, you must add additional memory. Contact your Panasonic dealer for details.

Note:

- This feature may not be effective for some applications.

Use Panasonic KX-P6500 Print Manager

Selecting "Use Panasonic KX-P6500 Print Manager" turns the Print Manager on when using GDI Mode. The KX-P6500 Print Manager allows you to use:

- 1st page on top (reverse order printing) ( P. 35)
- Duplex Printing ( P. 36)
- Overlay ( P. 36)
- Local Queue ( P. 29) both in GDI Mode as well as in PCL Mode

However, the print speed will be slower when the KX-P6500 Print Manager is activated.

1st Page On Top (Reverse Order)

The printer normally prints documents in page number order (i.e. page 1 first). Clicking on the check box at the left of "1st page on top (Reverse order)" will instruct the printer to print your output in reverse order.

OK

Click to make your changes take effect and return to the previous screen.

Cancel

Click to ignore any changes you have made and return to the previous screen.

Options

This button provides advanced GDI features, such as duplex printing, overlay, and reverse printing. Also see "Using Options" on page 36.

2 Up/4 Up

The printer lets you print 2 or 4 pages on a single sheet of paper. Also see "Using 2 Up/4 Up" on page 40.

About

Click to display the program version and copyright information.

Using the Printer in Windows

Using Options

- 1 Make sure that “Use Panasonic KX-P6500 Print Manager” is selected in the Panasonic KX-P6500 GDI window (P. 34).

- 2 Click **Options** in the Panasonic KX-P6500 GDI window.

The Options screen is displayed.

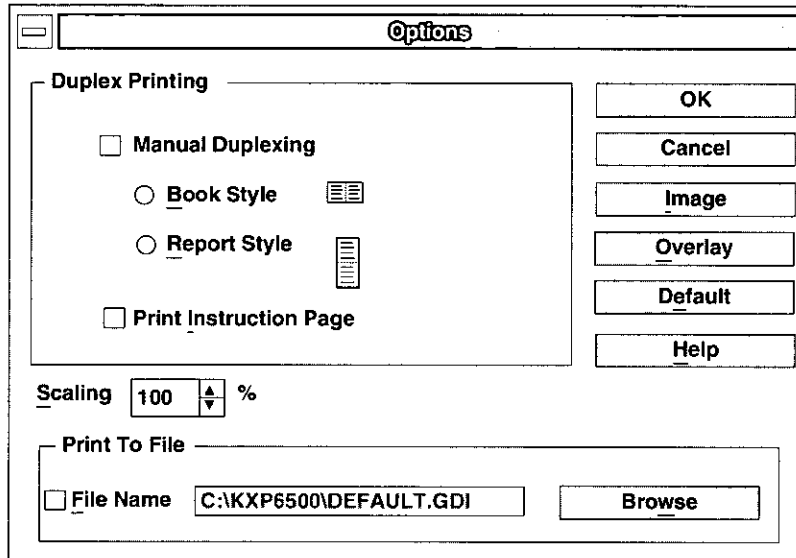

Duplex Printing

You can print your file on both sides of the paper by first selecting “Manual Duplexing”, then selecting either Book or Report. When performing this feature, follow the instructions displayed on the screen.

Scaling

Use Scaling to reduce or enlarge your output on the printed page from 10% to 500%.

Print to File

If you select File Name, the output will go to a file instead of the printer.

The print file is stored in GDI format. Use the Add button on the Local Queue of the KX-P6500 Console (P. 28) to print from a file.

Image

The Image feature lets you adjust the brightness and contrast of your output. Also see “Using Image Options” on page 40.

Overlay

The Overlay feature lets you overlay an image over any document printed in GDI Mode (P. 37).

Default

Click **Default** to restore all settings to their default values.

Help

Click **Help** for detailed information about the KX-P6500 for Workgroups Help system. Within the Help system, you can select Contents to see a list of topics related to the KX-P6500.

Using Overlay

You can use the Overlay feature to:

- Incorporate your letterhead on the first page of a business letter.
- Print your logo at the bottom of each page of a set of presentation slides.
- Overlay the word "Confidential" on every page of an important document.
- Print a special cover page or trailer page ( below) for each print job.

1 Ensure that the "Use Panasonic KX-P6500 Print Manager" is selected in the Panasonic KX-P6500 GDI window ( P. 34).

2 Click **Options**.

The Options screen is displayed ( P. 36).

3 Ensure that the "Manual Duplexing" in the Duplex printing box is disabled.

4 Click **Overlay**.

The Overlay Options screen is displayed.

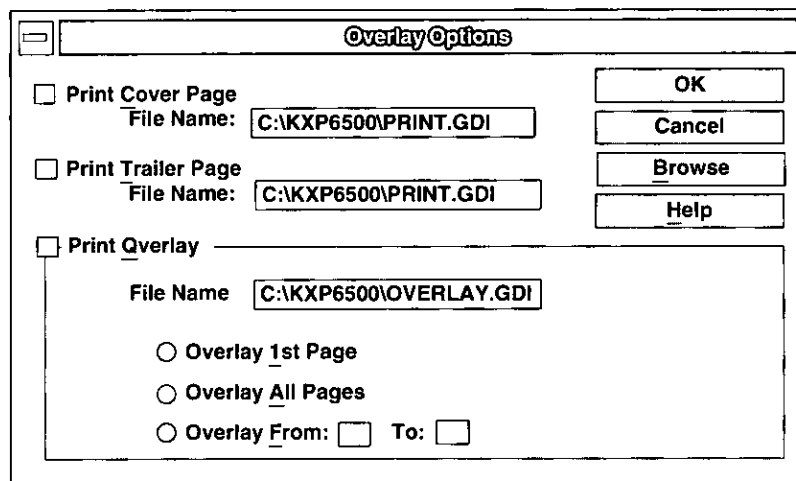

Print Cover Page

Select this feature to print a cover page on a separate page before the remainder of the document.

Print Trailer Page

Select this feature to print a trailer page on a separate page after the document has been printed.

Print Overlay

This feature will overlay your image on the pages of your document. The effect is similar to printing your image on a transparency, then putting the transparency over your document.

- Select Overlay 1st Page to overlay the image only on the first page of the document.
- Select Overlay All Pages to overlay the image on each page of the document.
- Select Overlay From to overlay the image on a range of pages within the document.

Browse

After selecting Print Cover Page, Print Trailer Page, or Print Overlay, clicking **Browse** will let you search for the GDI file in the file system.

Using the Printer in Windows

Overlaying and Printing a Document

- 1 Using an application such as Paintbrush, CorelDRAW or PageMaker, create and save the graphic file that you want to overlay on a document.
- 2 Verify the graphic by printing it, and minimize the application.
- 3 Perform steps 1 to 7 of "KX-P6500 GDI Mode" on page 34.

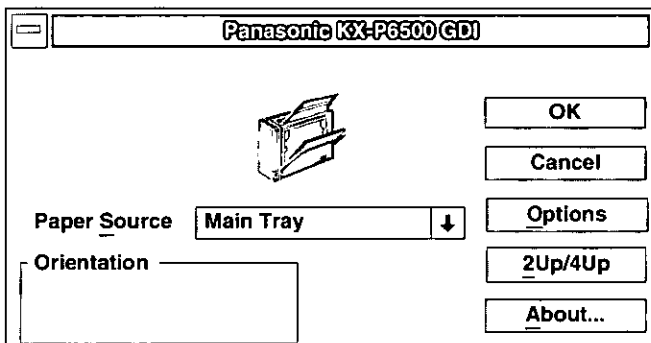

- 4 Click **Options**.

The Options window is displayed.

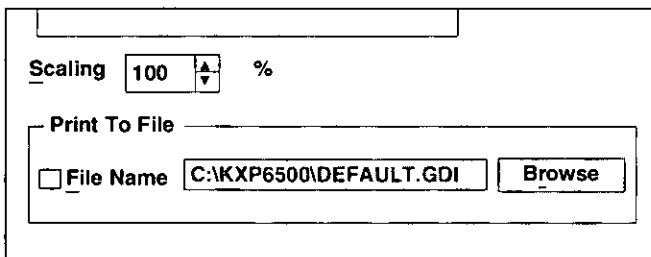

- 5 Select "File Name" by clicking on the check box at the left.

An X mark appears in the check box.

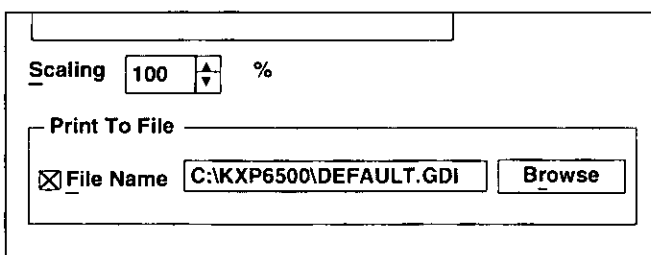

- 6 Enter a new file name or the same file name with the GDI extension (.GDI) and click **OK**.

- The GDI file extension must be used to designate the difference between a GDI file and an application file. Otherwise, the application file will be overwritten by a GDI file.

- 7 Click **OK** in the Panasonic KX-P6500 GDI window.

- 8 Minimize the KX-P6500 Console window.

- 9 Double click the same application which you minimized in step 2 and perform the print operation.

Your created file will be stored as a GDI file.

- 10 Perform steps 2 to 7 of "KX-P6500 GDI Mode" on page 34.

- 11 Select "Use Panasonic KX-P6500 Print Manager" by clicking on the check box.

An X mark appears in the check box.

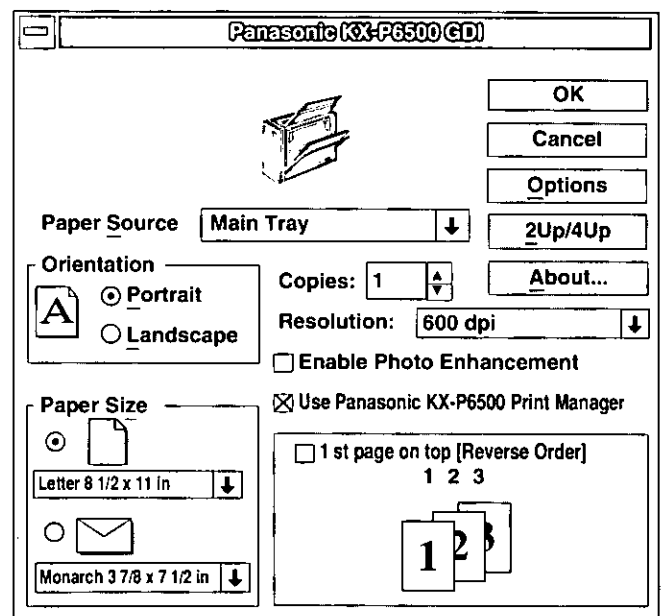

12 Click **Options**.

13 Deselect "File Name" by clicking off the check box at the left.

The X mark will be cleared from the check box.

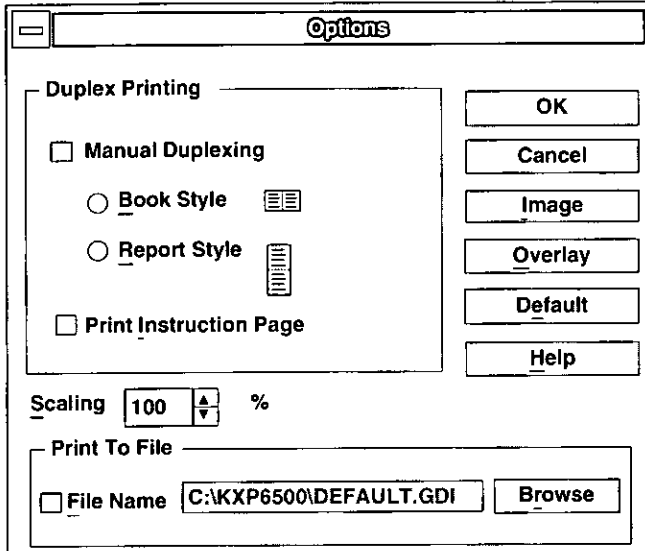

14 Click **Overlay**.

The Overlay Options window is displayed.

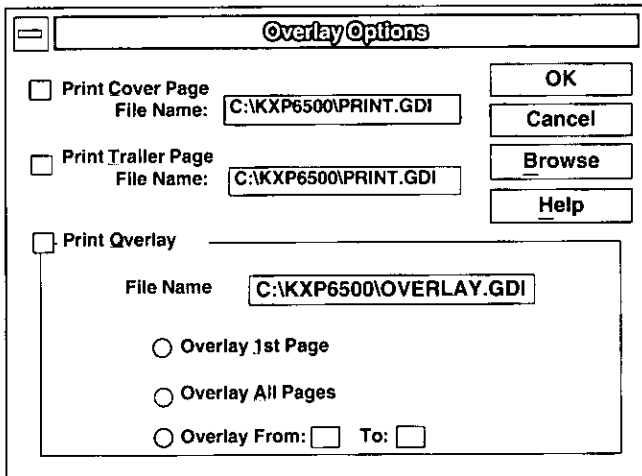

15 Click on the desired selection (s).

For example, select Print Cover Page.

16 Click **Browse**.

The Browse window is displayed.

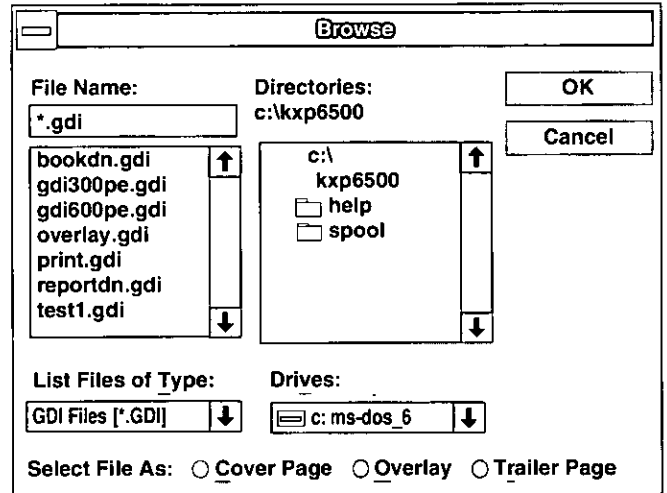

17 Double click on the directory in which you saved your graphic file (GDI file), then select the file and click **OK**.

The selected file will appear in a box in the Overlay Options window.

18 Click **OK** in the Overlay Options window.

19 Click **OK** in the Options windows.

20 Click **OK** in the Panasonic KX-P6500 GDI window.

21 Minimize the KX-P6500 Console window.

22 Print the desired document.

The graphic will be overlaid on the pages of your document.

Using the Printer in Windows

Using Image Options

- 1 Click **Options** in the Panasonic KX-P6500 GDI window (P. 34).

The Options screen is displayed.

- 2 Click **Image**.

The Image Options screen is displayed.

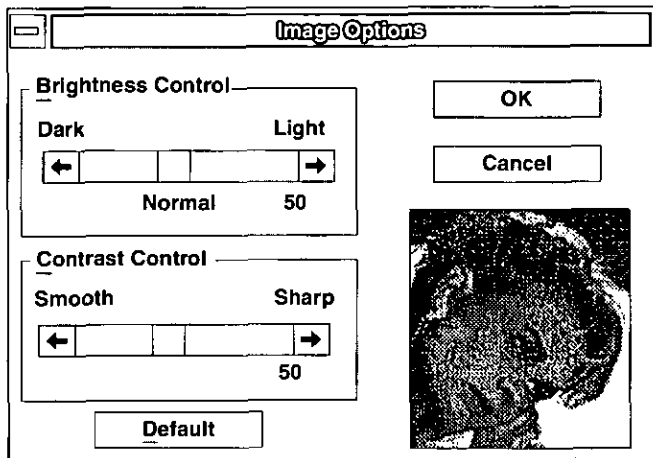

The Image Options screen lets you adjust the appearance of your output. These adjustments only apply to certain types of images and grayscales, not to text or black line drawings. Refer to page 32, Toner Saving Mode, for information on lightening the appearance of text and some line art.

The figure at the right of the screen will change as you move the controls, giving you a rough idea of the effect of your adjustments.

Note:

- This feature may not be effective for some applications.

Brightness Control

Drag the **Brightness** knob or click on the **arrows** to vary the shades of gray, making the image output appear lighter or darker.

Contrast Control

Drag the **Contrast** knob or click on the **arrows** to make the image output appear sharper or smoother.

Using 2 Up/4 Up

- 1 Click **2 Up/4 Up** in the Panasonic KX-P6500 GDI window.

The 2 Up/4 Up Printing screen is displayed.

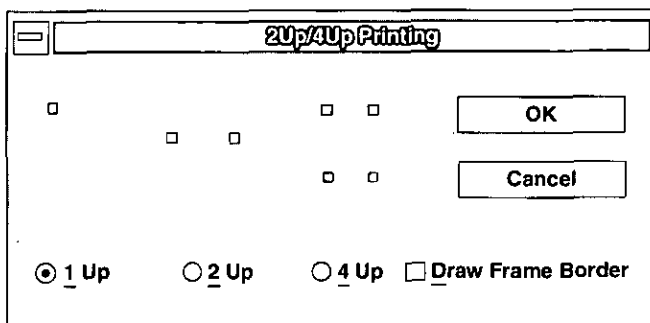

- **1 up:** prints normally.
- **2 up:** prints two pages on one sheet of paper. In portrait mode, the pages display side by side as in a book.
- **4 up:** prints four pages on one sheet of paper.

Draw Frame Border

If you click on **Draw Frame Border**, the printer will draw a box around each page on the paper.

KX-P6500 PCL Mode

You can select PCL Mode from an application, through the Control Panel's Printer window, or through the Control Panel tab of the KX-P6500 Console window (P. 27).

PCL Control Panel

The KX-P6500 for Workgroups lets you print from MS-DOS applications. Your printer also provides a PCL Control Panel similar to the conventional PCL printer's key panel for DOS PCL printing. This allows you to change printer settings for your DOS print jobs.

To display the Panasonic KX-P6500 PCL Control Panel, perform the following.

- 1 From the Program Manager double click the *Panasonic KX-P6500 Tools* icon.**

The Panasonic KX-P6500 Tools window is displayed.

- 2 Double click the *Panasonic KX-P6500 Console* icon.**

The KX-P6500 Console window is displayed.

- 3 Click the "Control Panel" tab.**

- 4 Click *PCL Control Panel* icon ().**

The Panasonic KX-P6500 PCL Control Panel window is displayed.

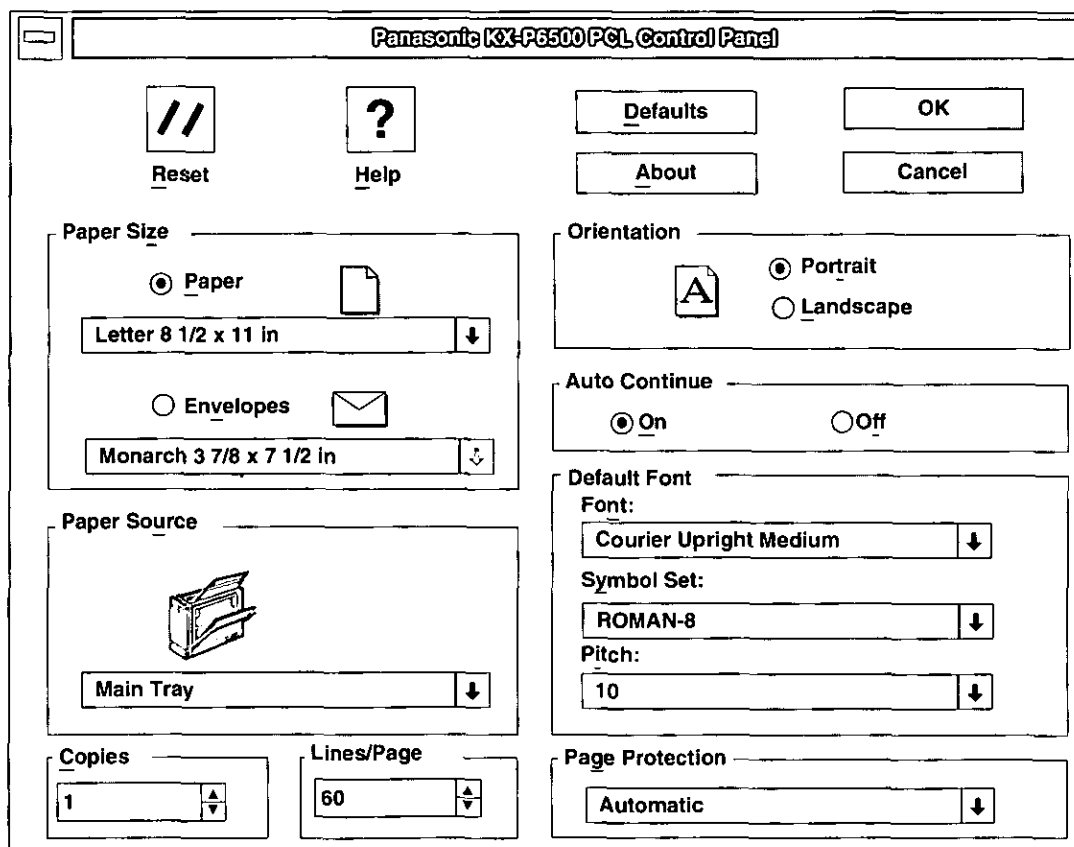

Using the Printer in Windows

Reset

After clicking the **Reset** button, the current displayed PCL Control Panel settings will be saved and the saved settings will be applied to succeeding PCL jobs. Present PCL printing job will not be affected.

Help

Click the **Help** button for detailed information about the KX-P6500 for Workgroups Help System.

Paper Size

To select paper/envelope from within the Paper Size box, first click on the paper/envelope icon. Then select the paper/envelope size that you wish to use.

Paper Source

Your printer has only one paper source, the Main tray.

Copies

Allows you to determine how many copies of the document will be printed.

Lines/Page

Allows you to set the maximum number of lines that can be printed on a page.

Orientation

Choose **Portrait** (vertical) or **Landscape** (horizontal).

Auto Continue

Specifies whether the printer should automatically resume the current print job after an error is corrected.

Default Font

Default font lets you select the default typeface, size, and style for print jobs that are output from MS-DOS applications and for Windows PCL print jobs. Both MS-DOS and Windows applications can override the default font selection.

- Please note that you do not have access to Windows TrueType fonts for MS-DOS print jobs.

Page Protection

Page Protection lets you select the reserve additional memory for PAGE PROTECTION. If you choose Automatic, it additionally reserves memory to process the entire page (in memory) composed with very dense or complex graphics and text before printing out of page. This setting assures complete printing. If you choose Off, it does not reserve additional memory.

Default

Click **Default** to restore all printer settings on the screen to their default values.

About

Click **About** to display the program version and copyright information.

OK

Click **OK** for your changes to take effect. When you exit, the PCL Control Panel will load the PCL compatible interpreter into your PC's memory. This will save time when printing from MS-DOS applications under Windows.

However, you can close the PCL compatible interpreter and recover the memory. Click the **KX-P6500 PCL Control Panel** icon, then click **Close**.

Cancel

Clicking **Cancel** will disregard any changes you have made to the PCL printer settings and will exit the PCL Control Panel without loading the PCL compatible interpreter.

KX-P6500 Printer Status

The Panasonic KX-P6500 Printer Status program has two primary functions:

- To let you monitor the status of the local printer.
- To alert you in case of a problem with your printer, such as paper out.

To display the Panasonic Printer Status window, perform the following.

- 1** From the Program Manager double click the *Panasonic KX-P6500 Tools* icon.
- 2** Double click the *KX-P6500 Console* icon.
- 3** Click the "Control Panel" tab.
- 4** Click **Local Printer Status** in the Printer box.

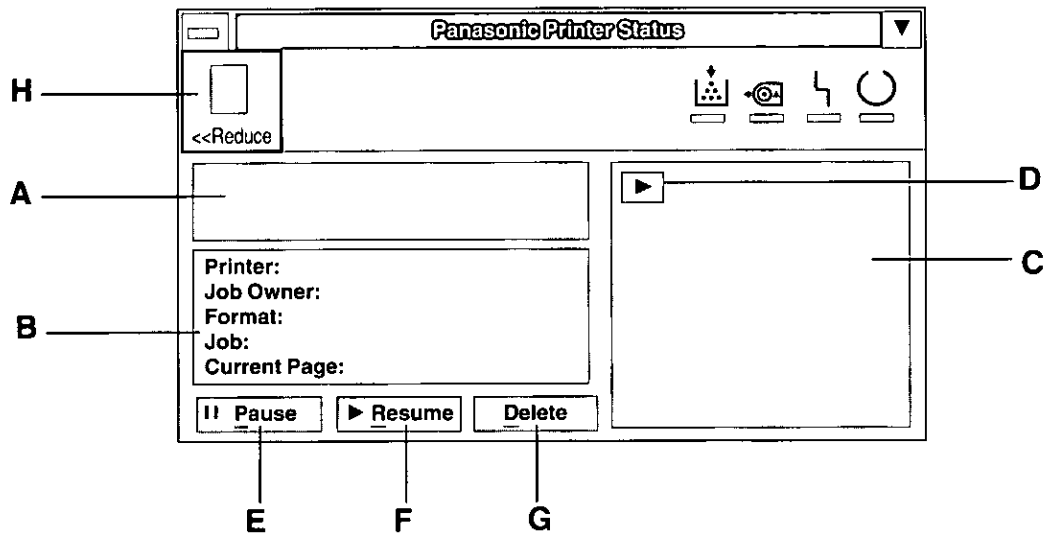

- This box shows an error or status message and corresponding icon.
- This box lists the name of the printer, the owner of the print job, the format of the print job, the name of the print job, and the page number for the job currently being printed.
- This box displays a picture of your printer. If a problem has occurred, an arrow identifies where the printer is affected. The display also provides corrective action for each error or status message.
- If you need additional help in resolving the problem, click . This animated help feature will walk you through the steps required to get your printer running once again.
- The **Pause** button lets you pause printing. For example, you can pause in order to cancel the print job from the application.
- The **Resume** button lets you resume printing after you have paused printing, or after recovering from an error situation.
- The **Delete** button lets you delete the job currently printing. You must pause the job before you can delete it, unless the printer itself is paused because of an error.
- Clicking this button will reduce the displayed screen and the box C will disappear.

Chapter 4 Using the Printer in MS-DOS

Printer Selection for DOS

The Printer driver is a part of the software that allows the application software to communicate with the printer via the interface in use.

If you wish to use a DOS application software program, you must perform the printer driver selection in your application software program.

The procedure will vary, depending on the software program. Consult your software package for proper procedures. The Panasonic KX-P6500 will be your first choice. However, if the Panasonic KX-P6500 printer is not listed in your software, you must select an alternative from the following table.

Printer Driver Selections (In order of priority)

Emulation
Panasonic KX-P6500
HP LaserJet Series IIP

Control Panel Software

The items listed in Control Panel are designed to correspond to the menu items on the front panel of a laser printer and possible additional printer features. Therefore, the Control Panel offers the user a way to set printer configuration settings and to know the printer's status.

The Control Panel software consists of two parts: Panasonic KX-P6500 Control Panel and KX-P6500 Control Panel Reporter (Status Display). The KX-P6500 Control Panel can work either in text display mode (monochrome or color) or graphics display mode on an IBM-compatible PC. Thus the screen designs in Control Panel will have two formats, Text and Graphics, according to the user's working PC configuration. The KX-P6500 Control Panel Reporter is a TSR program. Since it is desirable to minimize the program code in a TSR, Control Panel Reporter uses only Text display mode.

Note:

- If you have installed the KX-P6500 for Workgroups Software (P. 20) in Windows, the Control Panel software has also been installed at the same time. You do not need to install it in this section.

Installing the Control Panel Software

To install the Control Panel software onto your hard disk, follow the instructions below.

1 Insert the Control Panel Software disk 4 of 4 into disk drive A.

2 At the prompt, type A:\Setup and press **Enter**.

3 Press **Enter** to start the installation.

The Fast Installation window is displayed.

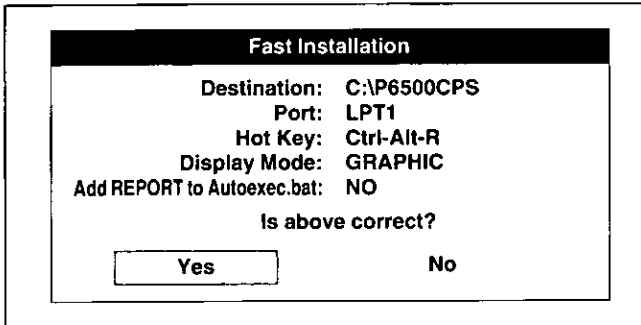

- If you do not wish to install the Control Panel software, press **Esc** to exit.

Destination:

This is the disk drive and directory onto which your software will be installed.

Port:

The Parallel port to which your printer is connected.

Hot Key:

Combination of keys which displays the KX-P6500 Control Panel Reporter window (P. 52).

Display Mode:

With GRAPHIC mode selected, the display will show graphics along with text. With TEXT mode selected, the graphics will not appear on the screen.

Add REPORT to Autoexec.bat:

If you want the Reporter to be loaded automatically whenever the computer is started or AUTOEXE.BAT is performed, select "Yes". Otherwise select "No".

- The above settings in the Fast Installation window can also be changed after installation of the Control Panel software.

4 If you do not wish to change any settings, press **Enter** and go to step 12.

5 If you wish to change a setting, select "No" and press **Enter**.

The Input Destination Path screen is displayed.

6 If you wish to install the Control Panel software on another drive and/or directory, type the letter of the drive and/or directory name, then press **Enter**. Otherwise just press **Enter**.

7 If you wish to change the port, use **↓/↑** to select the desired port, and press **Enter**. Otherwise just press **Enter**.

8 If you wish to change the hot key, press **Ctrl** + **Alt** + your desired key (A to Z), and press **Enter**. Otherwise just press **Enter**.

9 If you wish to change the display mode, use **↓/↑** to select the desired mode, and press **Enter**. Otherwise just press **Enter**.

10 If you wish to change the Add Report to Autoexec.bat, use **Tab** to select "Yes", and press **Enter**. Otherwise just press **Enter**.

11 If all the settings above are correct, press **Enter** to confirm.

- If you have made a mistake, select "No" by using **Tab**, and press **Enter**. In this case, you must perform steps 6-11 again.

12 The display will show the files being copied from floppy disk to hard disk.

13 When the Control Panel software installation is completed, the Complete Installation window is displayed.

14 Press **Enter** to exit.

Using the Printer in MS-DOS

KX-P6500 Control Panel

The Control Panel consists of 5 types of setting buttons (Page, Font, Quality, Memory and Other), and a title menu bar.

To display the Panasonic KX-P6500 Control Panel Software window, perform the following:

1 At the DOS prompt (C:>), type CD P6500CPS and press **Enter**.

2 Type CPS6500 and press **Enter**.

The Panasonic KX-P6500 Control Panel Software window is displayed.

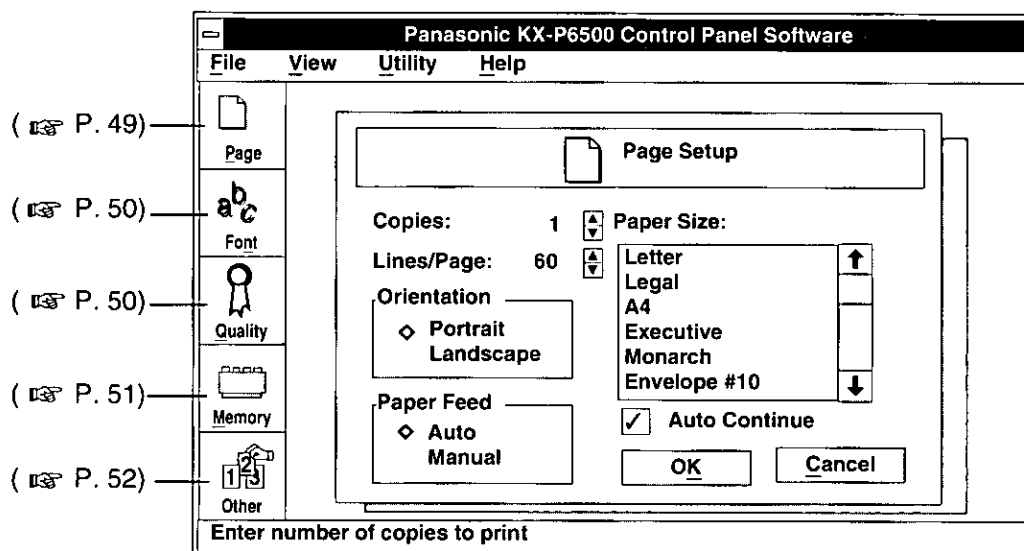

Changing the Printer Settings

You can proceed through the Control Panel using the computer keyboard or computer mouse.

Keys	Function	Keys	Function
Esc	Moves between menu bar and window	Tab	Advances to the next field in current window
→ / ←	Moves between menu bar items	Shift + Tab	Reverses to the previous field in current window
↓ / ↑	Moves between selections	Underlined character	Pulls down menu, displays window, or executes selection
Enter	Makes selection effective in current window		

Using the mouse: Highlight the selection and click the left mouse button.

File Menu

The File option lets you open, save, or apply printer profiles, which can be stored in the printer or as files on your PC's disk drive. The File option also lets you exit the Control Panel.

Note:

- Be sure to save your settings in a profile before turning off the power. If you turn off the power without saving the settings, they will return to the factory default settings.

When the File option is selected from the menu bar, a pull-down menu displays the following choices:

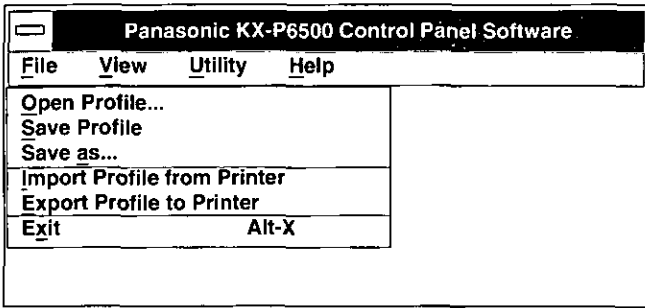

Open Profile

Selecting this option will allow you to open a printer profile that was previously saved as a file on your PC's disk drive. Control Panel settings will be updated based on the contents of the file. However, the profile will not be sent to the printer unless you select the Export Profile to Printer option on the File menu.

Save Profile

Selecting the Save Profile option will allow you to save all current settings in a profile on your PC's disk drive. If you opened a profile before making changes, this option will replace the old profile with this new one, using the same file name.

If you did not open a profile before making changes, the Save option will prompt you for a file name and directory before saving your profile to disk.

Save As

The Save As option lets you save the current profile to a disk file. The Control Panel will prompt you to enter a file name before saving the profile to disk.

Import Profile from Printer

This option reads the printer's configuration settings and uses them to create a printer profile. You can modify the profile through Control Panel options. You can also save the profile to disk.

Export Profile to Printer

This option updates the printer with the current profile settings.

Exit

Select this option to exit the Control Panel program. If you have made changes but not saved them in a profile or exported them to the printer, Control Panel will ask you to confirm before exiting.

View Menu

This option shows all the settings in the current printer profile. Information can be viewed but not changed from this screen.

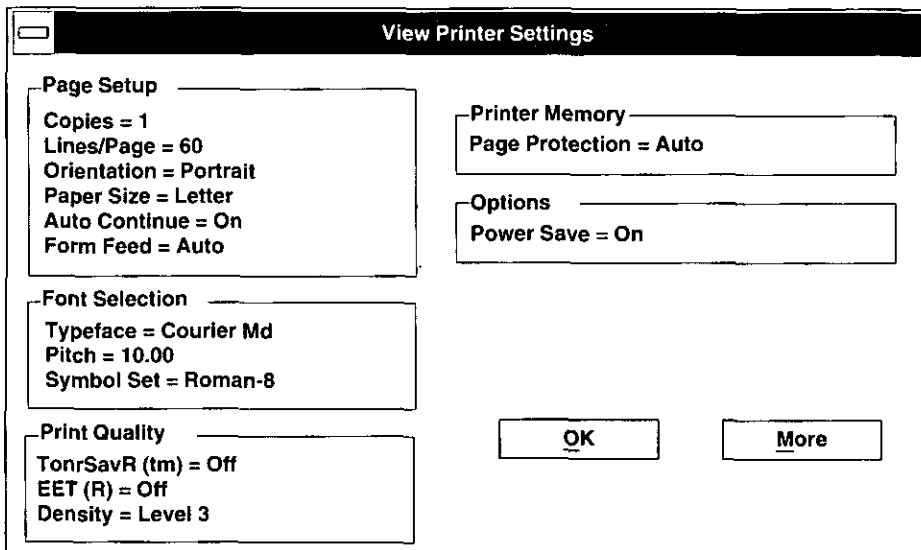

Using the Printer in MS-DOS

Utility Menu

The Utility menu lets you print several test pages, reset the printer, and connect the printer to a different port on your PC.

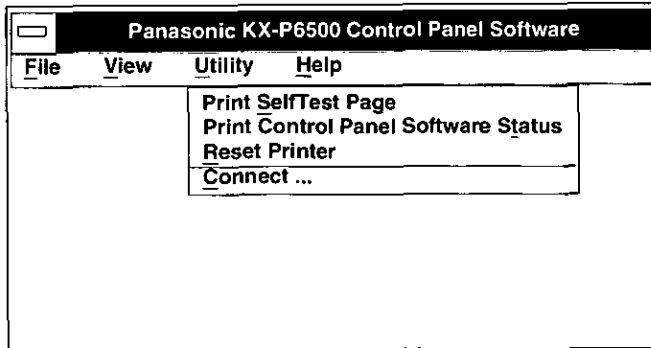

Print Self-Test Page

Instructs the printer to do a self-test and then print a test page. The test page contains information about the printer's current profile and can be used to determine output quality.

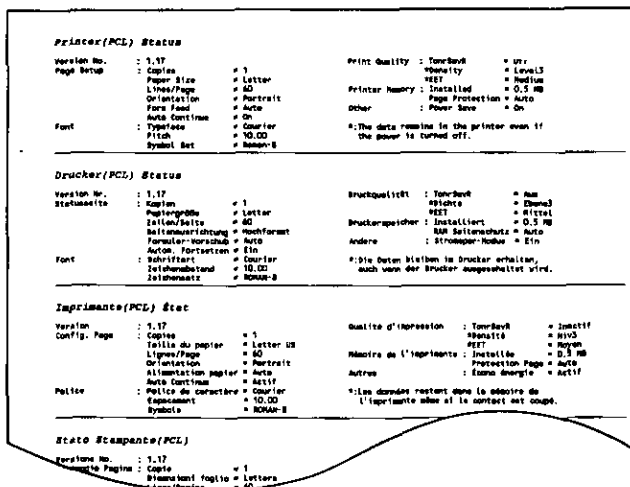

Print Control Panel Software Status

Prints a page showing the printer's current profile information.

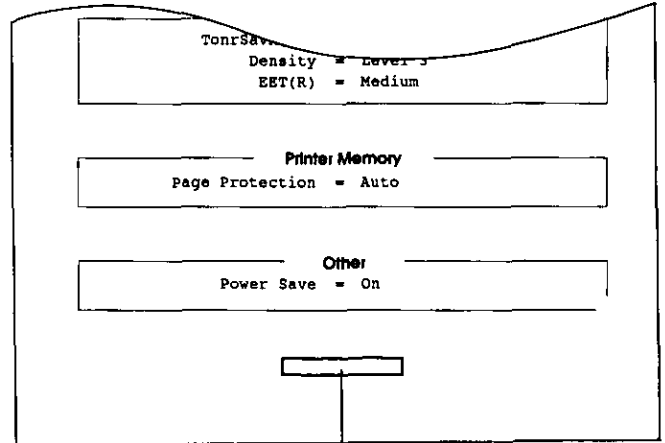

EET Test pattern (P. 51)

Reset Printer

Selecting Reset Printer will send a RESET command to the printer. This will reset all printer settings to their factory default values. It will also clear the printer's data buffer, so all current print job information will be lost.

Connect

Select a parallel port to which your printer is connected.

Help Menu

Press the F1 key at any time for help. A screen will show more information on the field where the cursor is currently located. Press **Alt** + **H** to see the Help Index.

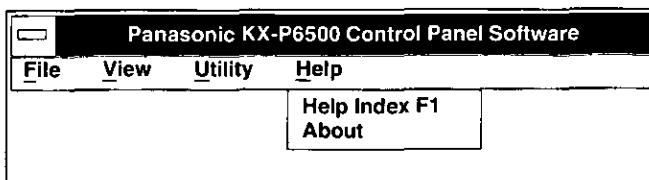

Help Index F1

Show help index screen.

About

Select About to see the program name, version number, and copyright information.

Control Panel Settings

The Control Panel can handle five types of settings: Page, Font, Quality, Memory, and Other. When you change a setting in one of these categories, then confirm by entering OK, Control Panel will send the updated settings to the printer.

Page Setting

The Page Setup option lets you update settings that affect the page.

The screenshot shows the 'Page Setup' dialog box. It includes fields for 'Copies' (1), 'Lines/Page' (60), 'Orientation' (Portrait selected), 'Form Feed' (Auto selected), 'Paper Size' (Letter selected), and an 'Auto Continue' checkbox (checked). 'OK' and 'Cancel' buttons are at the bottom.

Copies

Enter the number of copies that will be printed for each print job. You can enter any number between 1 and 999.

Lines/Page

Enter the maximum number of text lines to be printed on each page. You can enter any number between 5 and 128.

Note that if you change either orientation or paper size, the number of lines per page will be updated automatically to reflect the current orientation and paper size selections.

Orientation

Sets the printer to print in either **Portrait** (vertical) or **Landscape** (horizontal) mode.

Form Feed

Select whether the printer will feed paper automatically from a paper tray, or whether sheets of paper must be manually fed to the printer one at a time.

If you start printing when Manual is selected, the ERROR indicator on the printer will blink. If this occurs, paper will not be fed to the printer unless you press PRINT/RESET button for less than 5 seconds. However, if Auto Continue check box is clicked on, the ERROR indicator will blink for about 10 seconds, and then paper will be automatically fed.

Paper Size

Select the size of the paper loaded in the printer.

Auto Continue

Specifies whether the printer should automatically continue the current print job in the case of certain non-fatal errors.

OK

Enter OK to update the printer with the settings as they appear on the screen.

Cancel

Enter Cancel to ignore any changes made to the screen. All fields will be restored to their earlier settings, and the printer profile will not be updated.

Using the Printer in MS-DOS

Font Setting

The font option lets you select settings that define the font used to print text. These settings include typeface, pitch or point size, and symbol set.

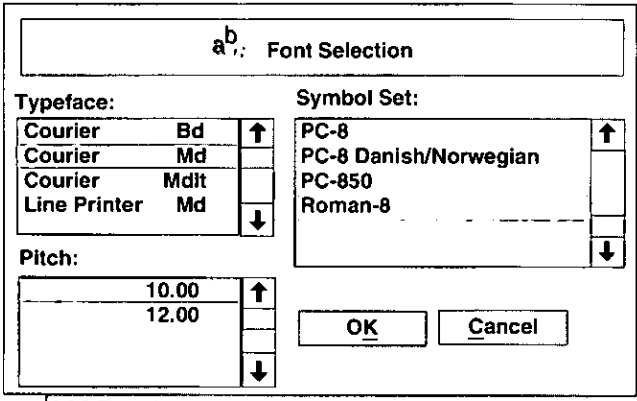

Typeface

Used to select a typeface (the unique name given to a specific set of characters and symbols with a characteristic design). The typeface, together with the symbol set and point size (for proportional typefaces) or pitch (for fixed space typefaces) will define a font.

When you select a typeface, the Control Panel shows only the symbol set and point size or pitch available for that typeface.

Symbol Set

A symbol set is a collection of alphabetic characters, punctuation marks, and numeric and special symbols. The Control Panel shows only the symbol sets available for the typeface currently selected on the Fonts screen.

Pitch

Pitch or point size describe the size of a font's characters.

Print Quality Setting

The Print Quality option lets you adjust the quality of your output.

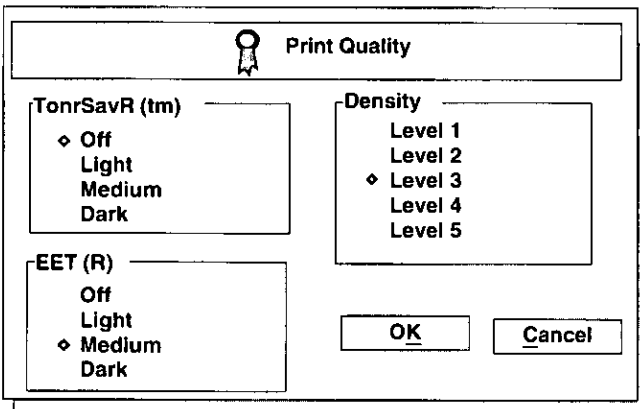

Toner Saving Mode

With Toner Saving Mode turned on, the KX-P6500 will reduce the amount of toner used to print the image. Black areas and text are replaced by a light gray shading.

- **Off:** This is the default setting and is recommended for the highest quality. Output appears normal.
- **Dark:** Text and graphics have a black outline along all edges. This setting is recommended over Light and Medium if you expect to fax or photocopy the document.
- **Medium:** Text and graphics have a black outline along the left and right edges.
- **Light:** Text and objects on the page have a black outline along the left edge.

EET (Edge Enhancement Technology)

With EET turned on, the KX-P6500 will smooth the jagged edges of text and line art, giving the output a very high quality appearance. There are three settings: **Light**, **Medium**, and **Dark**. The factory default setting is Medium. If the EET setting is too dark, the edges appear to bulge.

The print control panel software status (P. 48) has an Edge Enhancement test block. As a general guideline, select the EET setting so as to make this block look like a uniform gray block as shown in Figure 2.

If there are white vertical lines in the test print (Figure 1), set the EET to a darker setting. If there are dark vertical lines in the test print (Figure 3), set the EET to a lighter setting.



Figure 1



Figure 2

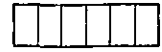

Figure 3

Note:

- The Density settings interact with EET. When you change the Density, readjust the EET setting.

Density

The Density option lets you choose from level 1 to level 5. To make the print lighter, choose a lower level button. To make the print darker, choose a higher level button.

Memory Setting

The Memory option lets you control how memory is used in the printer to avoid printing problems that could occur with certain types of page images.

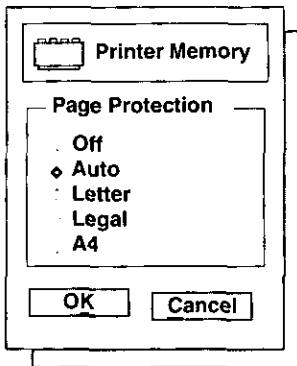

Page Protection

Specifies that the printer does not print a page until the entire page is fully composed. This allows the printer to print complex pages that would normally cause printer overrun errors.

The settings for Page Protection are Off, Auto (default) Letter, Legal, and A4. However, to use Letter, Legal or A4 setting, you need to install a RAM Expansion Board in the printer (P. 58).

Page Protection is not normally needed. However, if the printer receives an unusually complicated page that contains a complex image or layout, the printer might start to print the page before the processor can finish imaging the page. As a result the page might not print correctly.

If you turn on Page Protection to Letter, Legal, or A4, the printer reserves printer memory and does not begin printing until the processor has finished imaging the entire page. The page then prints correctly, although it takes slightly longer to print.

When Auto is selected, the printer first analyzes each page. If a page is complex, Page Protection is turned on automatically; otherwise, the printer prints the page without using Page Protection.

Using the Printer in MS-DOS

Other Setting

Choosing Other will allow control of the Power Saving Mode.

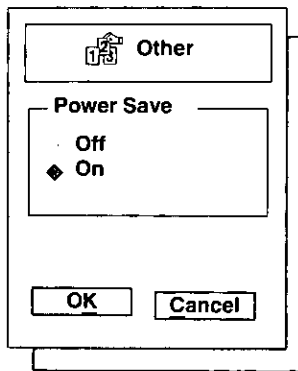

Power Save Mode

If the printer does not receive any activity from the computer for 15 minutes when power save is On, the printer will automatically drop down to low power usage mode until it is needed again.

KX-P6500 Control Panel Reporter

The Panasonic KX-P6500 Control Panel Reporter has two primary functions:

- allows you to control certain features of your printer.
- alerts you of any problems with your printer (P. 53).

To display the Panasonic KX-P6500 Control Panel Reporter window, perform the following:

- 1** At the DOS prompt, type `CD P6500CPS` and press **Enter**.
- 2** Type `REPORT` and press **Enter**.
 - Please ignore this step if "Add Report to Autoexec.bat" was set to "Yes" during installation of the Control Panel software (P. 44).
- 3** Press **Ctrl** + **Alt** + **R** simultaneously.

The Panasonic KX-P6500 Control Panel Reporter window is displayed.

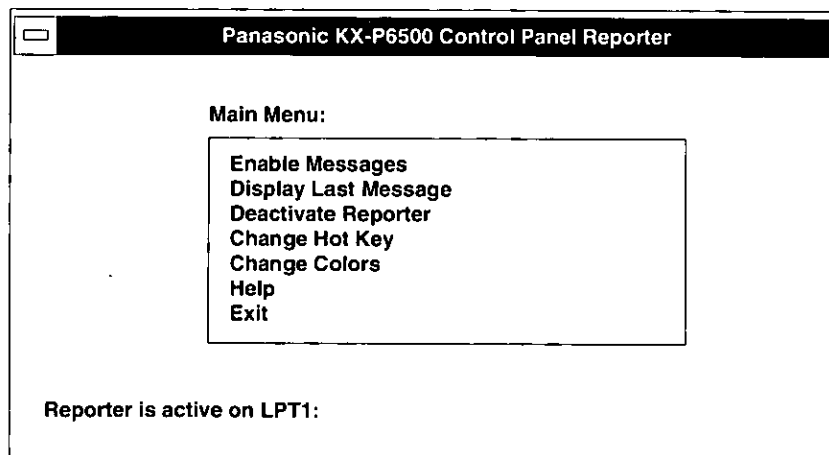

Enable Messages

Enable Messages lets you once again view error messages that have been disabled through the Disable Message command.

Display Last Message

Display Last Message lets you review the last printer error or warning message displayed by Reporter.

Deactivate Reporter

When Deactivate Reporter is selected, the Reporter stops checking the printer's status and does not display error and warning messages.

Activate Reporter

When Activate Reporter is selected, the Reporter resumes checking the printer's status and displays error and warning messages.

Change Hot Key

The Hot Key lets you run Reporter from DOS or a DOS program. Change Hot Key allows you to select a different hot key combination to run Reporter.

Change Colors

Change Colors allows you to select replacement colors for your Reporter status and menu displays.

Help

Help displays the detailed information about the KX-P6500's Help system. Within the Help system, you can select contents to see a list of topics related to the KX-P6500.

Exit

Exit returns you to DOS. Reporter remains in memory, able to monitor the printer, until you type REP /d at the DOS prompt.

Printer Status Messages

The Panasonic KX-P6500 Control Panel Reporter program will alert the user to any errors. It displays a warning or error message, identifies the problem area on the printer, and provides information regarding corrective action.

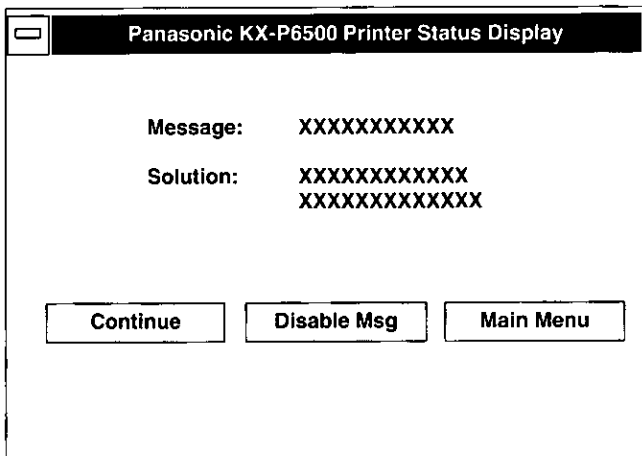

Continue

This button allows you to continue displaying the printer status messages.

Disable Msg

This button allows you to stop displaying the printer status messages.

Main Menu

This button allows you to display the Main Menu (P. 52).

Chapter 5 Care and Maintenance

Cleaning the Printer

Periodic cleaning of the printer is recommended. The frequency of cleaning is dependent upon the environment in which the printer is used. You should clean the printer:

- at least once a month.
- when you install a new Process Unit.
- when print quality has deteriorated.

External

- 1 Turn the power OFF.
- 2 Clean the cover with a soft cloth. Use any mild commercial cleaner.

Caution:

- Do not use benzine, thinner, aerosol cleaners, or any abrasive powder to clean the cabinet.

Internal

- 1 Turn the power OFF, open the left cover and remove the Process Unit. Before cleaning the inside of the printer, allow the fuser to cool (about 5 minutes).

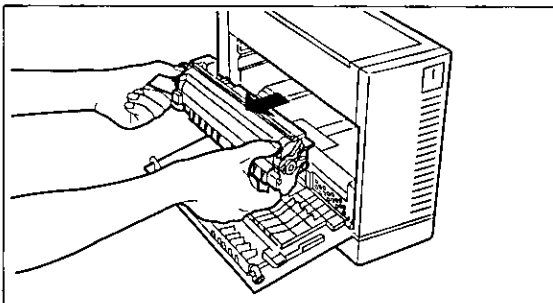

Cautions:

- The printer must be turned OFF prior to cleaning.
- Do not expose the Process Unit to light for more than 5 minutes, or to direct sunlight.
- Do not touch the green drum surface of the Process Unit.

- 2 Clean the following areas with a dry cloth or a cotton swab.

With a dry cloth

- Pinch roller
- Feed roller
- Transfer roller
- Paper chute (Paper dust)

With a cotton swab

- Carefully wipe the tungsten wire and the laser unit mirror by sliding a cotton swab from end to end 4 to 5 times.

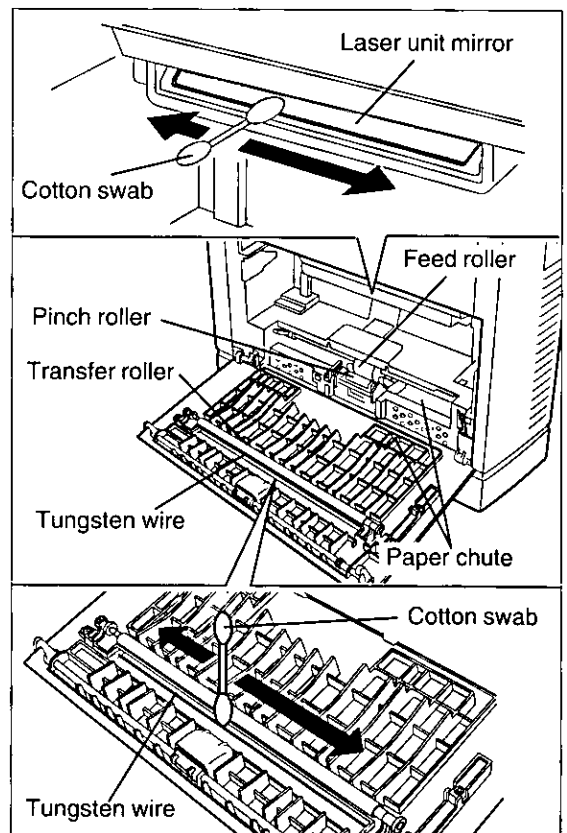

- 3 Close the left cover.

Troubleshooting

Many problems associated with the printer can be traced to improper setup or cabling. The following table will assist you in identifying and correcting some of the more common problems.

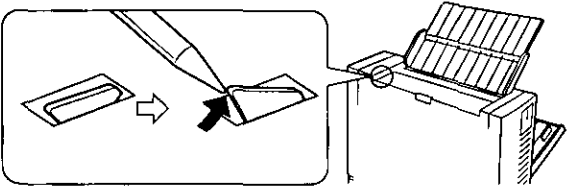









Trouble	Possible Cause	Corrective Action
LED not blinking	No AC power	Check power cord.
Power on but printer not printing data	Interface cable not connected	Check interface cable.
Stains on paper	Dirty paper path	Clean paper path (P. 54).
Vertical line on paper	Dirty paper path	Clean paper path (P. 54).
	Dirty tungsten wire	Clean tungsten wire (P. 54).
	Dirty laser unit mirror	Clean the laser unit mirror (P. 54).
	Scratch on drum	Replace Process Unit.
Scratch on fuser roller	Scratch on fuser roller	Replace fuser. The printer requires service by an Authorized Panasonic Service Center.
	Scratch on fuser roller	Replace fuser. The printer requires service by an Authorized Panasonic Service Center.
Very faint print	Toner may be empty	Shake the Process Unit or refill the toner in the Process Unit (P. 58).
	Print density not adjusted	Select the proper print density (P. 32, 51).
	Abnormal transfer corona current	Replace the transfer corona. The printer requires service by an Authorized Panasonic Service Center.
Horizontal faint grey stripe(s) appear on the printout	The Process Unit was exposed to light for more than 5 minutes, or to direct sunlight	These stripes will automatically disappear after a few hours.
Paper jams occur continually	The paper size selected through the GDI Mode, PCL Mode, or Control Panel and software application are different from the installed paper size	Select the correct paper size through the GDI Mode (P. 34) or PCL Mode (P. 41), or Control Panel (P. 46) and application.
After removing the jammed paper, the ERROR indicator still blinks	Paper fragment(s) remains in the printer	Move the sensor lever to the upright position by using an object like a ball point pen. The remaining fragment(s) will be ejected. 
Ejected paper is caught between the paper support and the output tray	There is a space between the output tray and the paper support	Slide the paper support down, then extend it again to remove the space (Step 1 on page 15).
Paper jam has occurred	Follow the instructions displayed on the screen. If stains appear on the back of the printed paper after a paper jam is cleared, it is recommended that you run several test prints. For Windows users: (P. 24)/For DOS users: (P. 48)	

(continued)

Care and Maintenance

Trouble	Possible Cause	Corrective Action
Printout is raggedy	Screen fonts may be selected	Replace the screen fonts with TrueType fonts. To show only TrueType fonts in applications, follow the procedure below. <ol style="list-style-type: none"> 1. Double click the Main icon in the Program Manager. 2. Double click the Control Panel icon. 3. Double click the Fonts icon. 4. Click TrueType. 5. Select "Show Only TrueType Fonts in Applications", and click OK to exit the TrueType dialog box.

Error Indication

Indicators			Possible Cause	Recovery
 ERROR	 READY	 TONER/ PROCESS UNIT		
	<input type="checkbox"/>	<input type="checkbox"/>	Output tray (top cover) is not open.	Open the output tray (top cover).
			Paper jam has occurred.	Remove the jammed paper, then open the left cover and close it.
			Paper tray is empty.	Load paper in the paper tray and press the PRINT/RESET button (< 5 seconds).
			Left cover is open.	Close the left cover.
			RAM overflow or overrun has occurred.	Press the PRINT/RESET button (< 5 seconds).
<input type="checkbox"/>	<input type="checkbox"/>		Toner may be empty.	Refill the toner or shake the Process Unit (P. 58).
<input type="checkbox"/>	<input type="checkbox"/>	 *1	Toner may be empty and the life cycle of the Process Unit has expired.	Install a new Process Unit when the toner supply is depleted.
<input type="checkbox"/>	<input type="checkbox"/>	 *2	The life cycle of the Process Unit has expired.	
	<input type="checkbox"/>		Process Unit is not installed.	Install the Process Unit (P. 13).
	<input type="checkbox"/> *3	<input type="checkbox"/>	Internal errors.	If the ERROR indicator is lit, turn the power off for a few seconds then on again. If the error continues, service by an Authorized Panasonic Service Center is required.

 : on  : blinking (fast – with an interval of about 1 second)

: off  : blinking (slow – with an interval of about 2.5 seconds)

*1 You still can refill the toner, but it is recommended that you replace the Process Unit as soon as possible to maintain maximum print quality.

*2 You can print additional pages until the toner supply is depleted, but it is recommended that you replace the Process Unit as soon as possible to maintain maximum print quality.

*3 Varies depending on the condition.

Repacking Instructions

It is highly recommended that you keep the original carton and ALL packing materials. Should you need to transport or ship your printer, please follow these instructions.

Please Note:

- Should you need to send your printer to a Service Center, consult your dealer first.
- Please use the original carton and all of the original packing material.
- Improper repacking of the printer may result in a service charge to repair the unit or a cleaning charge to remove spilled toner.
- Since the printer uses dry toner, extreme care must be taken when handling. The printer should be handled in the upright (vertical) position.

Material Required:

- Original Printer Carton and Packing Materials
- Original Process Unit Packing Materials
- Newspaper or drop cloth
- Shipping Tape and Scissors

- 1** Disconnect the AC line cord and the printer/computer cable.
- 2** Close the paper support and the output tray (top cover).
- 3** Open the left cover.
- 4** Remove the Process Unit by holding the green labeled tabs and pulling it toward you.

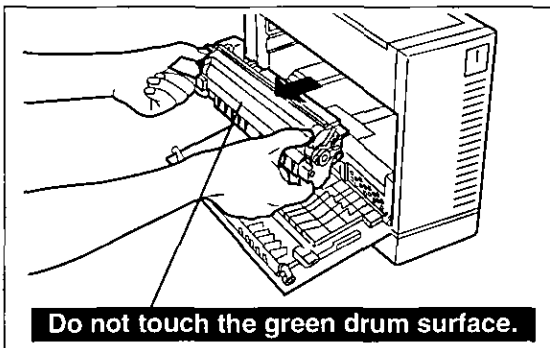

- 5** **1** Place the protective sheet over the green drum.
2 Put the Process Unit into the plastic bag and close the bag.

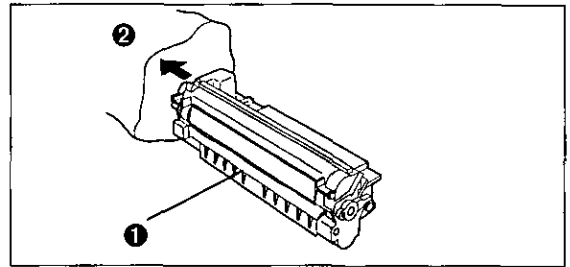

- 6** Install the Process Unit by holding the green labeled tabs and pushing it into the printer.

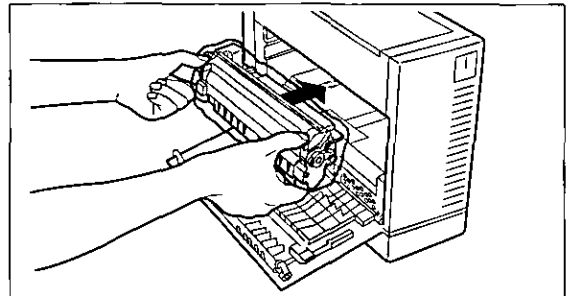

- 7** Close the left cover.
- 8** Repack the printer.

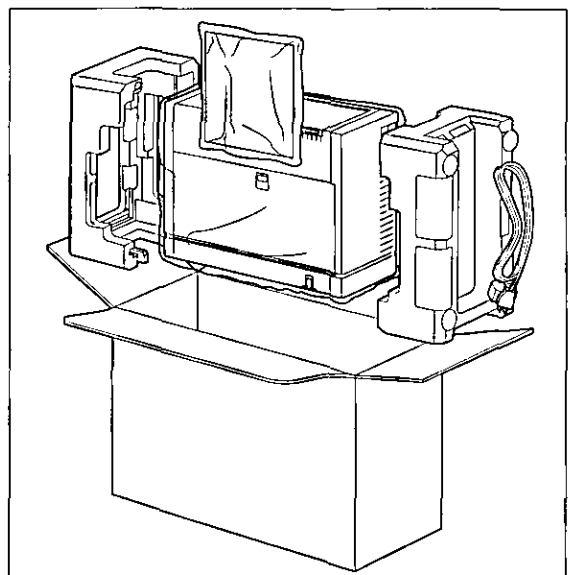

Appendix

Options and Supplies

Please contact your local Panasonic dealer for availability. The following options and supplies include Instructions/Installation Manuals.

Options		Supplies	
KX-P447	1MB RAM Expansion Board	KX-P458	Toner Cartridge — 2,000 page life
KX-P448 or KX-PEM5	2MB RAM Expansion Board	KX-PEP4	Process Unit — 15,000 page life
KX-PEM6	4MB RAM Expansion Board		
KX-PNW1 *	WfW Multi User Pack		

Note:

- Page life is based upon printing 4% image area with repetitive printing of 10 pages.

* With this option installed on the PC, the connected printer (KX-P6500/KX-P6100) can provide a service to a maximum of 25 PCs.

Adding Toner

When the print is faint and the toner message is displayed, the toner supply may be almost depleted. However, the printer may print additional pages if you shake the Process Unit a few times. Fill the toner in the Process Unit using toner cartridge KX-P458. The instructions below are the outline procedures. For detailed instructions, please refer to the KX-P458 instructions manual.

Extending the toner life:

- 1 Shake the Process Unit.

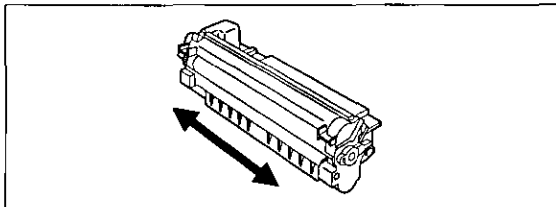

Refilling the toner:

- 1 Remove the Process Unit from the printer (Steps 1~5 on P. 57).
- 2 Open the toner cover of the Process Unit.

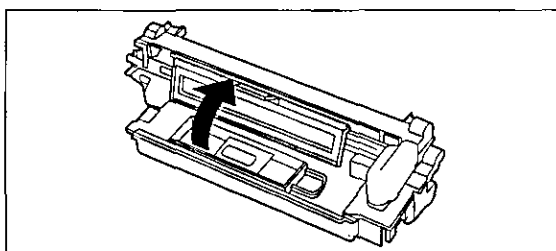

- 3 Remove the affixed protective sheet from the toner cartridge.

- 4 Place the toner cartridge on the Process Unit, and slide the toner cartridge to the left until it stops.

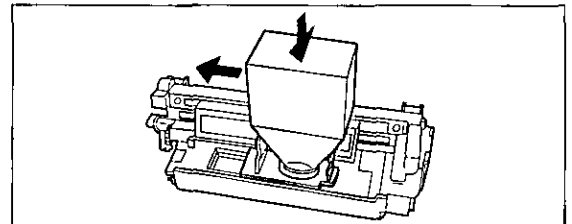

- 5 Shake the Process Unit, and tap the toner cartridge to let the toner fall into the Process Unit.

- 6 Remove the toner cartridge by sliding it to the right and lifting.

Cautions:

- Use of toner other than Genuine Panasonic Toner KX-P458 can damage this process unit and the printer's fuser. THIS WILL VOID THE WARRANTY OF THE PRINTER AND PROCESS UNIT.
- Do not expose the Process Unit to light for more than 5 minutes, or to direct sunlight.

Using a KX-P6100 Printer with KX-P6500 for Workgroups Software

You can use a KX-P6100 printer with KX-P6500 for Workgroups software (P. 20) in Windows. However, you cannot connect both the KX-P6100 and KX-P6500 printers to the same server.

- 1** Be sure the KX-P6500 for Workgroups software has been installed on the Server PC.
- 2** Connect the KX-P6100 printer to the Server PC, and turn the printer on.
- 3** At the DOS prompt, type WIN and press to start Windows in the 386 Enhanced Mode.
- 4** From the Program Manager, double click the *Panasonic KX-P6100 Tools* icon.
- 5** Double click the *KX-P6500 Console* icon.

The KX-P6500 Console window will be displayed.
- 6** Click the "Settings" menu.
- 7** Select "Local Printer Change".
- 8** Click "Printer On".
- 9** Click .

GDI>> Panasonic KX-P6100 GDI and PCL>> Panasonic KX-P6100 PCL will be displayed in the Printer box.
- 10** Select "GDI>> Panasonic KX-P6100 GDI" or "PCL>> Panasonic KX-P6100 PCL" depending on your desired print mode.
- 11** Click .

Appendix

Printer Specifications

Printing Method:
Semiconductor Laser
Print Speed:
6 pages per minute (ppm) maximum (Letter size paper, text mode, 5% image area, all originals)
Resolution:
600 dots per inch (dpi) [when GDI mode] and 300 dpi [when PCL mode]
Paper Feed:
1 Multi-purpose tray up to 100 sheets [75 g/m ² (20 lbs.)]
Paper Output:
Up to 50 sheets
Power Source:
Refer to the nameplate on the rear of the unit
Software Emulation *1 :
HP LaserJet Series IIP
Fonts:
GDI mode: (TrueType fonts in Windows)
PCL mode: Courier 10 point, 12 pitch: Regular, Bold, Italic Courier 12 point, 10 pitch: Regular, Bold, Italic Line Printer 8.5 point, 16.66 pitch: Regular
RAM Buffer:
512 KB (expandable to a maximum of 1.5 MB with optional 1 MB RAM Board, 2.5 MB with 2 MB RAM Board and 4.5 MB with optional 4 MB RAM Board.)
Interface:
Bidirectional parallel (IEEE P1284)
Operating Environment:
10 to 32.5°C (50 to 90.5°F) 20 to 80% RH

Storage Environment:
0 to 35°C {32 to 95°F} 10 to 80% RH
Dimensions:
132 (W) × 378 (D) × 287 (H) mm {5.2" × 14.9" × 11.3"}
Mass (Weight):
Approx. 6.5 kg {14.4 lbs.}
Consumables/Life:
Starter toner *2; 1,000 pages average (4% image area with repetitive printing of 10 pages) Toner cartridge; 2,000 pages average (4% image area with repetitive printing of 10 pages) Process unit; 15,000 pages average (4% image area with repetitive printing of 10 pages)
4% image area means that the black area within the printing area is 4%. Printing 8% image area continuously will reduce the life of the toner and of the Process Unit to about half as compared to printing 4% image area. The "Toner Saving Mode" allows you to save the toner and to maintain the life of the Process Unit (P. 32, 50).
Power Consumption:
480 W TYPICAL (Printing with Fuser on) 9 W TYPICAL (Power Saving Mode)
Noise Level:
Printing: 45 dBA Standby: Background noise level
CPU:
Motorola MC68EC000 (16MHz)
Power Saving Mode:
To conserve energy and reduce operating cost, this printer is provided with a power save feature. If the printer has not received data for 15 minutes, the printer will automatically enter a power saving mode.

*1 Emulation means to operate like another printer.

*2 This toner is installed in the Process Unit at the factory before shipment of the printer.

Paper Specifications

This printer is designed to work well with most types of paper. However, differences in paper may have significant effects on the quality of the print or the reliability of paper handling. It is strongly recommended that you always test paper before purchasing it to make sure it provides desirable performance. The following guidelines will be helpful.

Paper Specifications

Basic Weight:
60 to 135 g/m ² (16 to 36 lbs.)
Thickness:
3.7 to 7.5 mils (1 mil=1/1000")
Moisture Content:
4% to 6%
Smoothness:
100 to 300 Sheffield
Acid Content:
5.5 PH minimum
Fusing Compatibility:
Must not scorch, melt, offset material, or release hazardous emissions when heated to 200°C (392°F) for 0.1 second

Cutting Dimensions:
±0.0313 inch of nominal, corners 90°±4°
Grain:
Long grain
Cut Edge Conditions:
Cut with sharp blades, no paper dust
Ash Content:
Not to exceed 10%
Curl:
No allowable curl toward the side to be printed
Packing:
Poly laminated moisture proof ream wrap

Note:

- Please store your paper according to the recommendations of the manufacturer.

Paper and Envelope Sizes

The following paper and envelope sizes are supported by the KX-P6500.

Medium	Name	Dimension
Paper	Letter	8.5" × 11" (216 × 279 mm)
	Legal	8.5" × 14" (216 × 356 mm)
	A4	8.27" × 11.7" (210 × 297 mm)
	Executive	7.25" × 10.5" (184.1 × 266.7 mm)
	B5 *	7.17" × 10.12" (182 × 257 mm)
	A5 *	5.83" × 8.27" (148 × 210 mm)
Envelope	Business #10	4.13" × 9.5" (104.9 × 241.3 mm)
	Monarch	3.88" × 7.5" (98.5 × 190.5 mm)
	International DL	4.33" × 8.66" (110 × 220 mm)
	International C5	6.4" × 9.02" (162 × 229 mm)

* A5 and B5 size papers can be used only in the GDI Mode.

Appendix

Types of Paper to Avoid

- Extremely smooth or shiny paper or paper that is highly textured
- Coated papers
- Letterhead imprinted with low temperature or thermography. These materials may transfer onto the fusing roller and cause damage. Any pre-printed paper should use inks compatible with 200°C (392°F) for 0.1 second.
- Damaged or wrinkled paper, or paper with irregularities such as tabs, staples, etc.
- Multipart forms or carbonless paper
- Paper with a cotton and/or fibre content over 25%

Two-Sided Printing

Two-sided printing is possible. However, you should not expect the same print quality and reliability that you get with one-sided printing. We strongly recommend that you follow the guidelines below.

- Use 75 to 90 g/m² (20 to 24 lbs.) paper. [Do not use 60 g/m² (16 lbs.) paper.]
- Do not load more than 50 sheets in the paper tray.
- Before loading paper in the tray, adjust it so that the edges are even.

Transparencies and Labels

You may also print on labels and transparencies that are made for the printer. Panasonic has tested and found that the following work satisfactorily.

OHP transparencies	3M154, 3M688, 3M688C, SCOTCH8803, 3M/SCOTCH-CG3300, 3M PP2500
Labels	AVERY 5160, AVERY 5162 Avery Copier Labels (70 × 36 mm) Avery White (105 × 37 mm) 16 labels per sheet COPY TACK C-16, C-24 ESSELTE DATALINE, ESSELTE KOPIETIKETTER 15914, 15917, 15920, 15922 FASTONALL COPY-LINE 18-030, 18-033, 18-034, 18-035, 18-036, 18-037 HERMA Copy-print 4455, 4464

Note:

- With any label stock, the labels must completely cover the backing material. (See figure below)

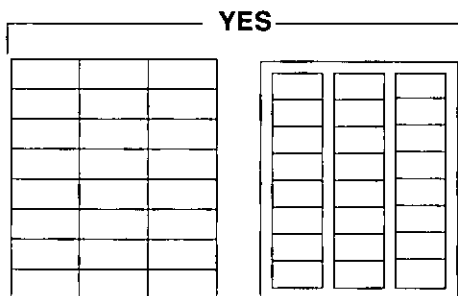

Labels cover the entire backing material

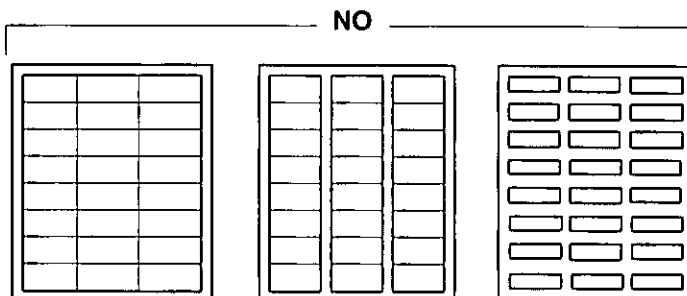

The backing material is exposed.

Envelope Specifications

It is recommended that you purchase only high quality envelopes with diagonal seams, as shown in the diagram below:

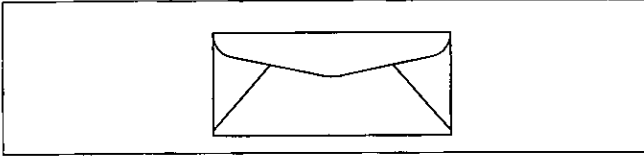

High quality envelopes have the following characteristics:

- A thin, sharply creased leading edge
- Paper weight or 90 g/m² (24 lbs.)
- Flat, free of curls, wrinkles, nicks, etc.

It is not recommended that you use envelopes with any of the following characteristics (using these may result in paper jams):

- Irregularly shaped envelopes
- Envelopes with curls, wrinkles, nicks, twists, dog-ears or other damage
- Envelopes with side seam construction
- Highly textured envelopes, or with extremely shiny surfaces
- Envelopes that seal by removing a peel-off strip
- Envelopes with more than one flap to be sealed
- Self-adhesive envelopes
- Envelopes that are baggy or not sharply creased
- Embossed envelopes
- Envelopes that have previously been printed on

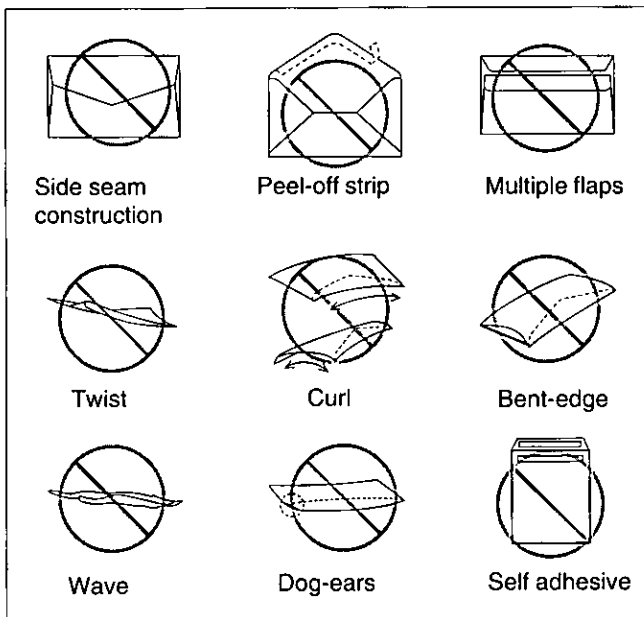

Do not attempt to print on any of the following types of envelopes. These may cause damage to your printer.

- Envelopes with clasps, snaps or tie strings (see Figure 1)
- Envelopes with transparent windows (see Figure 2)
- Envelopes that will melt, discolor, scorch offset or release hazardous emissions when exposed to 200°C (392°F) for 0.1 second
- Envelopes that use encapsulated types of adhesive that do not require moistening but rely on pressure to seal them

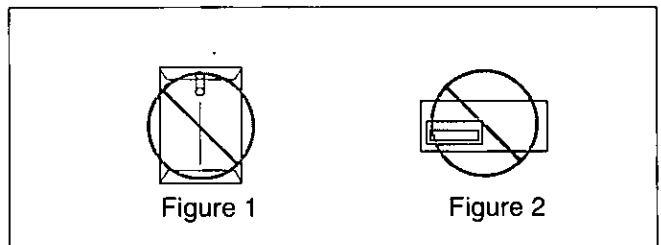

Always test a sample of the envelopes you are thinking of buying. Confirm that the envelope performs acceptably.

For best printing results

- Avoid printing in high humidity i.e., above 70%. High humidity may cause the envelope to curl and pick up excess toner. High humidity may also cause the envelope to seal.
- Avoid printing below 10°C (50°F) with less than 30% relative humidity. Low temperature with low humidity may cause light printing.

Envelope storage is very important. Store them away from moisture and humid air, where they can lay flat and their edges won't be bent or damaged. The humidity should not exceed 70% RH.

Appendix

Interface Specifications

Bidirectional Parallel Interface

The bidirectional parallel interface is based on the IEEE P1284-B standard.

If your computer has a bidirectional parallel port, the printer driver and printer can take advantage of the fastest possible data transfer.

Specifications:

connector type	57-30360 (AMPHENOL) or equivalent
cable	use a shielded cable 2 meters (6.6 feet) or less in length

Pin configuration

Signal pin	Return side pin	Signal
1	19	nStrobe
2	20	Data 1
3	21	Data 2
4	22	Data 3
5	23	Data 4
6	24	Data 5
7	25	Data 6
8	26	Data 7
9	27	Data 8
10	28	nAck
11	29	Busy
12	28	PError

Signal pin	Return side pin	Signal
13	28	Select
14	30	nAutoFd
15		
16		SG
17		FG
18		+5V
31	30	ninit
32	29	nFault
33		
34		
35		
36	30	nSelectin

Parallel Interface connector (printer side)

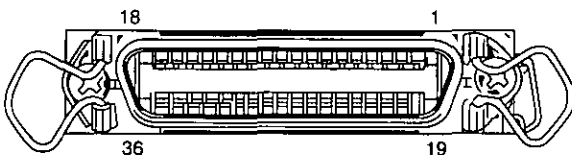

Notes:

- "Return" denotes the return side wire of a twisted pair cable and is connected to signal ground.
- Be sure to use only a shielded cable. The printer will not operate properly if any of the pins are not connected.

Index

A

Adding Toner	58
Automatic emulation switching	25

B

Bidirectional parallel interface	8, 60, 64
--	-----------

C

Cable	64
Carton enclosures	10
Caution	3
Cautions	9
Changing the print mode	26
Cleaning printer	54
external	54
internal	54
Configuration Overview	17
Installing the Network connection	18
Network Configuration	17
Client	18
Server	17
Network example	18
Personal Configuration	17
Connecting a Client PC	23
Connecting the Printer and Power On	14
Connector type	64
Console window	27
Console Menu Items	32
File	32
Network	33
Run	33
Settings	32
View	32
Control Panel	27
Job Log	31
Local Queue	29
Remote Queue	30
Consumables/Life	60
Control Panel Software	44
Installing	44
Control Panel Software window	46
File menu	46
Exit	47
Export Profile to Printer	47
Import Profile from Printer	47
Open Profile	46
Save as	47
Save Profile	47
Font setting	46, 50
Help menu	46, 48
Memory setting	46, 51
Other setting	46, 52
Page setting	46, 49
Print Quality setting	46, 50

Utility menu	46, 48
Connect	48
Print Control Panel Software Status	48
Print SelfTest page	48
Reset Printer	48
View menu	46, 47
Control Panel Reporter	52
Control Panel Reporter window	52
Change Colors	52, 53
Change Hot Key	52, 53
Deactivate/Activate Reporter	53
Display Last Message	53
Enable Messages	53
Exit	52, 53
Help	52, 53
Copies	34, 42, 49
Cotton swab	54

D

Density	50, 51
Duplexing	36

E

Emulation	25, 60
Envelopes	16
loading	16
sizes	61
Error indication	56
EET (Edge Enhancement Technology)	8, 32, 51

F

Feed roller	54
Font Selection screen	50
Pitch	50
Symbol Set	50
Typeface	50
Fonts	60
Frame ground terminal	11, 14
Frame ground wire	14

G

GDI Mode	8, 34
GDI window	34
Copies	34, 35
Options	34, 35
Orientation	34, 35
Landscape	34, 35
Portrait	34, 35
Paper Size	34, 35
Paper Source	34, 35
Resolution	34, 35
Enable Photo Enhancement	34, 35
Use Print Manager	34, 35
1st page on top (Reverse Order)	34, 35
2 Up/4 Up	34, 35, 40

Index

I

Image Options screen	40
Brightness Control	40
Contrast Control	40
Indicators	11, 12
ERROR	12
READY	12
TONER/PROCESS UNIT	12
Installation	
printer stands	13
process unit	13
Interface cable, parallel	14
Interface connector, parallel	14, 64

K

KX-P6500 for Workgroups software	20
Installing	20
Windows 3.1 Printer Driver & Utilities	20
Windows 95 Printer Driver & Utilities	21
Removing	24

L

Labels	16, 62
Landscape	34, 42, 49
Left cover	11
LINES/PAGE	42, 49
Loading Paper	15
Envelopes (Labels, Transparencies)	16

M

Minimum Space Requirements	9
--------------------------------------	---

N

Noise Level	60
-----------------------	----

O

OHP Transparencies	62
Options	58
Options screen	36
Duplex Printing	36
Manual Duplexing	36
Print Instruction Page	36
Image	36, 40
Overlay	36, 37
Print To File	36
Scaling	36
Output Quality screen	50
Density	51
EET	51
Toner Saving Mode	50
Output tray	11

Overlay	36, 37
Overlay Options Screen	37
Browse	37
Print Cover Page	37
Print Overlay	37
Overlay 1st Page	37
Overlay All Pages	37
Print Trailer Page	37

P

Packing Material	14
Page Setup screen	49
Auto Continue	49
Copies	49
Lines/Page	49
Orientation (Portrait, Landscape)	49
Paper Feed (Auto, Manual)	49
Paper Size	49
Paper	15, 61
chute	54
feed	60
output	60
sizes	61
specifications	61
support	11, 15
tray	11, 15
Parallel interface	60, 64
cable	14
connector	11, 14, 64
Part names	11
PCL Control Panel window	41
Auto Continue	41, 42
Copies	41, 42
Default Font	41, 42
Lines/Page	41, 42
Orientation	41, 42
Landscape	41, 42
Portrait	41, 42
Paper Size	41, 42
Paper Source	41, 42
Page Protection	41, 42
Reset	41, 42
PCL Mode	8, 41
Photo Enhancement	34, 35
Pinch roller	54
Portrait	34, 42, 49
Power connector plug	11, 14
Power Consumption	60
Power cord	10, 14
Power on	14
Power Saving Mode	8, 32, 52
Power Source	9
Power switch	11, 14
Preparation	13
Print Modes	25
GDI Mode	34
PCL Mode	41

PRINT/RESET button 12

Printer Features 8

Printer Memory screen 51

 Page Protection 51

Printer stands 13

Printer Status 43

 Printer Status window 43

Printer Status Display 53

 Continue 53

 Disable Msg 53

 Main Menu 53

Printing

 Two-Sided 62

 OHP Transparencies 62

 Labels 62

Printing Documents 25

 From a Windows application 25

 From a DOS application 25

Process unit 10, 13, 14, 58

R

Repacking 57

Resolution 34

S

Sharing the Printer 23

 Stop sharing 23

Software

 disks 10

 installing 20, 44

Specifications

 envelopes 63

 interface 64

 paper 61

 printer 60

Supplies 58

System Requirements

 for Windows 10

 for MS-DOS 11

T

Testing the Printer 24

Trademark Acknowledgement 3

Transfer roller 54

Troubleshooting 55

Tungsten wire 54

Two-Sided Printing 62

Types of Paper to Avoid 62

Toner Saving Mode 8, 32, 50

U

Use Print Manager 35

2 Up/4 Up screen 40

 Draw Frame Border 40

 1 Up/2 Up/4 Up 40

V

Ventilation 9

Virtual Memory 19

W

Warning 3

FOR USERS IN THE CONTINENTAL UNITED STATES ONLY

Panasonic Warranty Policy

Panasonic Communications & Systems Company ("PCSC") will repair or exchange your unit (exclusive of Consumables and Limited Life Items listed below) with a new or comparable rebuilt unit in exchange for the defective unit, free of charge, in the U.S.A. for (1) year from the date of original purchase in the event of a defect in materials or workmanship.

Consumables and Limited Life Items

PCSC will repair/replace the Process Unit and/or Toner with new or rebuilt parts, free of charge, in the U.S.A. for the shorter of ninety (90) days from the date of original purchase or the rated life of the item in the event of a defect in materials or workmanship.

When you unpack your printer, you should find a process unit and power cord. If either/both of these parts are missing or defective,

– or –

If you have followed the set up instructions in this Operating Instructions manual and the printer fails to turn on or "CALL SERVICE Exx" appears on the computer screen, please call 1-800-222-0584.
(xx denotes a two digit number representing an error code)

**Panasonic Communications & Systems Company,
Computer Products Division
Division of Matsushita Electric Corporation of America**
Two Panasonic Way, Secaucus, New Jersey 07094

**Panasonic Sales Company
Division of Matsushita Electric of Puerto Rico, Inc.**
San Gabriel Industrial Park, 65th Infantry Avenue KM. 9.5
Carolina, Puerto Rico 00630

Matsushita Electric of Canada Limited
5770 Ambler Drive, Mississauga, Ontario, L4W 2T3

Matsushita Electric Industrial Co., Ltd.
Central P.O. Box 288, Osaka 530-91, Japan
